

# OMRON®

## Instruction Manual

# Full Body Sensor Body Composition Monitor and Scale

Model **HBF-514C**

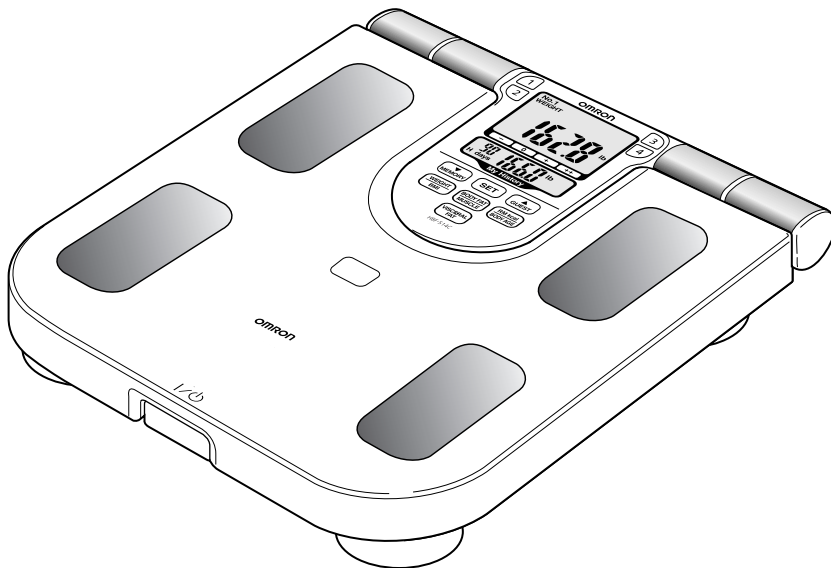

# TABLE OF CONTENTS

## Before Using the Monitor

Introduction .....	3
Intended Use.....	4
Safety Information .....	5
Information on Body Composition .....	7
Principles of Full Body Sensing Calculations .....	7
Body Mass Index.....	8
Body Fat .....	8
Visceral Fat.....	9
Resting Metabolism.....	10
Skeletal Muscle .....	11
Body Age .....	11
Long-term Planning for Successful Weight Loss .....	12
Recommended Measurement Times .....	13

## Operating Instructions

Know Your Unit .....	15
Battery Installation.....	18
Setting the Date and Time .....	20
Setting Personal Data .....	22
Changing Personal Data .....	24
Deleting Personal Data.....	25
How to Take a Measurement.....	26
Understanding Your Measurement Results .....	31
How to Measure Weight Only.....	32
How to Use the Memory Function.....	33

## Care and Maintenance

Error Indicators .....	38
Troubleshooting Tips.....	39
Care and Maintenance.....	40
FCC Statement .....	41
Warranty .....	42
Specifications .....	43

# INTRODUCTION

Thank you for purchasing the OMRON<sup>®</sup> HBF-514C Full Body Sensor Body Composition Monitor and Scale.

*Fill in for future reference.*

*DATE PURCHASED:* \_\_\_\_\_

*SERIAL NUMBER:* \_\_\_\_\_

*Staple your purchase receipt here*

The Full Body Sensor Body Composition Monitor and Scale is easy to use. The monitor calculates the estimated values for body fat percentage, skeletal muscle percentage, resting metabolism and visceral fat level using the BI (Bioelectrical Impedance) Method. The monitor also calculates the BMI (Body Mass Index) and body age as well as weight. Push the power switch on, select your Personal Profile Number, and step onto the measurement platform. The personal memory function can be used to store data for up to four personal profiles. The memory function stores the measurement results for each personal profile from 1 day, 7 days, 30 days and 90 days ago, along with high and low readings for each type of measurement result.

# INTENDED USE

The Omron body composition monitor with scale is intended to be used to calculate and display the estimated value of body fat percentage, skeletal muscle percentage, resting metabolism, BMI and visceral fat levels using the BI (Bioelectrical Impedance) Method and indicates the BMI (Body Mass Index).

The Omron body composition monitor with scale is intended to be used by healthy individuals in the age range of 18 to 80 years for the skeletal muscle percentage, resting metabolism and visceral fat level.

The age range for body fat percentage is intended to be used by healthy individuals between the age of 10 to 80 years.

Your HBF-514C comes with the following components:

- Monitor/Scale
- Instruction Manual
- 4 “AA” Batteries
- Measurement Log Sheet

## **WARNING**

Do not use, or allow others to use, this monitor if fitted with a cardiac pacemaker or other implanted medical device.

## **WARNING**



Pregnant women should not use this device.

 Read all of the information in the instruction manual and any other literature in the box before operating the unit.















# SAVE THESE INSTRUCTIONS

# SAFETY INFORMATION

To assure the correct use of the product, basic safety measures should always be followed including the warnings and cautions listed in this instruction manual.

SAFETY SYMBOLS USED IN THIS INSTRUCTION MANUAL	
 Warning	Indicates a potentially hazardous situation which, if not avoided, could result in death or serious injury.
 Caution	Indicates a potentially hazardous situation which, if not avoided, may result in minor or moderate injury to the user or patient or damage to the equipment or other property.

## OPERATING THE DEVICE

-  Do not use this monitor if you have a cardiac pacemaker or other implanted medical device. The Full Body Sensor Body Composition Monitor and Scale passes an extremely weak electrical current of 50kHz and less than 500 $\mu$ A through your body when taking a measurement to determine the amount of fat tissue. This weak current is not felt while using the monitor. Do not use, or allow others to use, this monitor if fitted with a cardiac pacemaker or other medical device.
-  Pregnant women should not use this device.
-  Contact your physician or healthcare provider before beginning a weight reduction or exercise program.
-  Keep the monitor out of the reach of young children. The cord can become entangled and cause strangulation.
-  Persons with disabilities or persons who are physically frail should be assisted by another person when using this monitor or use a handrail, a walker, or other support device to prevent falling when stepping on and off the monitor.
-  Read all of the information in the instruction manual and any other literature in the box before operating the unit.
-  Do not use mobile telephones, microwave ovens or other devices that generate strong electrical or electromagnetic fields near the monitor. This may result in an operational failure.
-  Do not step on the edge or the display area of the measurement platform. The monitor may tilt. The display unit may be damaged.
-  Do not step on the measurement platform when your body or feet are wet, for example after taking a bath or shower. You may slide and lose your balance.
-  Do not place the monitor on a cushioned floor surface such as a carpet or mat. A correct measurement may not be possible.
-  Do not use the unit on slippery surfaces such as tile floors or wet floors. The monitor may move. You may lose your balance and fall.
-  Do not jump on the measurement platform. You may lose your balance and fall. The monitor may be damaged.
-  Stand on the measurement platform with bare feet. Attempting to stand on the measurement platform when wearing socks may cause you to slip and lose your balance.
-  Do not insert the batteries with their polarities incorrectly aligned.

# SAFETY INFORMATION

## OPERATING THE DEVICE (continued)

- ⚠ Do not use new and worn batteries together.
- ⚠ Do not use batteries of a different kind together.
- ⚠ Replace old batteries with new ones immediately. Replace all four batteries at the same time.
- ⚠ Remove the batteries if the unit will not be used for three months or more.
- ⚠ Do not expose the batteries to flames or fire.
- ⚠ Should battery fluid leak and contact your eyes, skin or clothing immediately rinse with plenty of clean water. Immediately contact your physician in case of eye or skin contact.
- ⚠ Dispose of the device, batteries, components and optional accessories according to applicable local regulations. Unlawful disposal may cause environmental pollution.
- ⚠ Operate the unit only as intended. Do not use for any other purpose.
- ⚠ This unit is intended for home use only. It is not intended for professional use in hospitals or other medical facilities. This unit does not support the standards required for professional use.
- ⚠ Remove the display unit from main unit before stepping on the unit. If you try to remove the display unit while stepping on to the unit, you may lose your balance and fall.
- ⚠ Do not hold the handle inside the electrode grips when storing the display unit in the display unit holder. Your fingers could be trapped between the handle and the unit.

## CARE AND MAINTENANCE

- ⚠ Do not disassemble or modify the unit. Changes or modifications not approved by Omron Healthcare will void the user warranty.
- ⚠ Do not subject the monitor to strong shocks, such as dropping the unit on the floor.
- ⚠ Do not submerge the device or any of the components in water.



# INFORMATION ON BODY COMPOSITION

## PRINCIPLES OF FULL BODY SENSING CALCULATIONS

### ***What is Full Body Sensing?***

Full Body Sensing provides a comprehensive understanding of your body composition to help you reach and/or maintain your fitness goals. Unlike other body composition monitors that rely on foot-to-foot measurements, Omron's monitor measures the whole body (arm to foot) which provides a clinically-proven accurate profile.

### ***How Omron calculates your body composition:***

Omron's algorithm focuses on the Bioelectrical Impedance Method as well as height, weight, age and gender.

**Bioelectrical Impedance Method:** The Omron Full Body Sensor Body Composition Monitor and Scale estimates the body fat percentage by the Bioelectrical Impedance Method. Muscles, blood, bones and body tissues with high water content conduct electricity easily. On the other hand, body fat does not store much water, therefore has little electric conductivity. The Omron Full Body Sensor Body Composition Monitor and Scale sends an extremely weak electrical current of 50 kHz and less than 500  $\mu\text{A}$  through your body to determine the amount of water in each tissue. You will not notice or feel the electrical current.

The ratios of the water in your upper and lower body change throughout the day – as gravity pulls more water into your lower extremities. This means the electrical impedance of the body also varies – if more water is in your legs, other monitors such as foot-to-foot may show incorrect body fat readings. The Omron Full Body Sensor Body Composition Monitor and Scale takes measurements from both hands and feet – which reduces the influence water movement makes on your body composition results.

# INFORMATION ON BODY COMPOSITION

## BODY MASS INDEX

Body Mass Index (BMI) is a number calculated from a person's weight and height. BMI is a reliable indicator of body fatness for people. BMI does not measure body fat directly, but research has shown that BMI correlates to direct measures of body fat. BMI is used as a screening tool to identify possible weight problems for adults.

BMI is calculated by using the following formula based on a ratio between your weight and height:

$$\text{BMI} = \text{weight (lb)} / \text{height (inches)} / \text{height (inches)} \times 703$$

### Interpreting the BMI Result

BMI	BMI (Designation by the WHO)	BMI Classification Bar				BMI Rating
		-	0	+	++	
Less than 18.5	- (Underweight)					7.0 - 10.7 10.8 - 14.5 14.6 - 18.4
18.5 or more and less than 25	0 (Normal)					18.5 - 20.5 20.6 - 22.7 22.8 - 24.9
25 or more and less than 30	+ (Overweight)					25.0 - 26.5 26.6 - 28.2 28.3 - 29.9
30 or more	++ (Obese)					30.0 - 34.9 35.0 - 39.9 40.0 - 90.0

Source: Values for obesity judgment proposed by WHO, the World Health Organization.

## BODY FAT

Body fat serves a vital role in storing energy and protecting internal organs. We carry two types of fat in our bodies: 1) essential fat which is stored in small amounts to protect the body and 2) stored fat which is stocked for energy during physical activity. While too much body fat may be unhealthy, having too little fat can be just as unhealthy. Also, the distribution of body fat in men and women is different, so the basis for classifying the body fat percentage is different between the genders.

### Interpreting the Body Fat Percentage Result

Gender	Age	Low (-)	Normal (0)	High (+)	Very High (++)
Female	20-39	< 21.0	21.0 - 32.9	33.0 - 38.9	≥ 39.0
	40-59	< 23.0	23.0 - 33.9	34.0 - 39.9	≥ 40.0
	60-79	< 24.0	24.0 - 35.9	36.0 - 41.9	≥ 42.0
Male	20-39	< 8.0	8.0 - 19.9	20.0 - 24.9	≥ 25.0
	40-59	< 11.0	11.0 - 21.9	22.0 - 27.9	≥ 28.0
	60-79	< 13.0	13.0 - 24.9	25.0 - 29.9	≥ 30.0

Source: NIH/WHO guidelines for BMI

Source: Gallagher et al., American Journal of Clinical Nutrition, Vol. 72, Sept. 2000



# INFORMATION ON BODY COMPOSITION

## VISCERAL FAT

Visceral fat is found in the abdomen and surrounding vital organs. It is different from fat found directly underneath the skin, which is referred to as subcutaneous fat. Visceral fat can go largely unnoticed because it's not visible to the naked eye. One way visceral fat can be seen is through Magnetic Resonance Imaging (MRI).

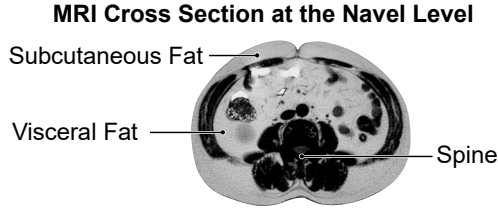

Too much visceral fat is thought to be closely linked to increased levels of fat in the bloodstream, which may lead to conditions such as high cholesterol, heart disease and type 2 diabetes. In order to prevent or improve these conditions, it is important to try to reduce the amount of visceral fat levels to an acceptable level.

### *Interpreting the Visceral Fat Level Result*

Visceral Fat Level $\leq 9$	$10 \leq$ Visceral Fat Level $\leq 14$	Visceral Fat Level $\geq 15$
<b>0 (Normal)</b>	<b>+ (High)</b>	<b>++ (Very High)</b>

Visceral fat area (0 - approx. 300 cm<sup>2</sup>, 1 inch=2.54 cm) distribution with 30 levels.  
Source: Omron Healthcare

**NOTE:** Visceral fat levels are relative and not absolute values.

# INFORMATION ON BODY COMPOSITION

## RESTING METABOLISM

Regardless of your activity level, a minimum level of caloric intake is required to sustain the body's everyday functions. Known as the resting metabolism, this indicates how many calories you need to ingest in order to provide enough energy for your body to function.

### **60-70% of daily energy use is for resting metabolism**

The total amount of energy used by the body in a typical day is as follows:

Resting metabolism	Energy required to maintain vital functions.
Daily activity metabolism	Energy used for daily activities such as commuting to work, household chores, hobbies etc.
Diet-induced thermogenesis	Energy emitted after eating a meal.

The ratio of these is 60%-70% for resting metabolism, 20%-30% for daily activity, and 10% for diet induced thermogenesis. This means that resting metabolism accounts for most of our daily energy consumption.

If our daily caloric intake exceeds the amount of energy required for these activities, the additional calories can be stored as fat.

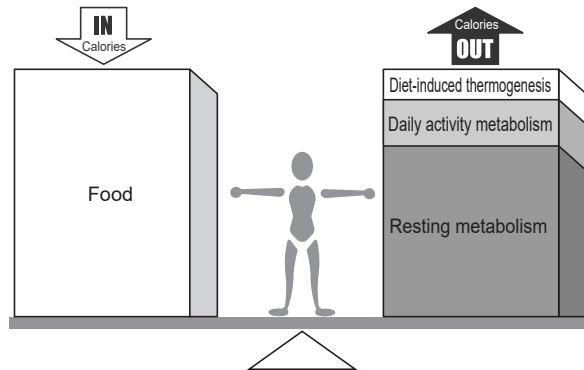



# INFORMATION ON BODY COMPOSITION

## SKELETAL MUSCLE

Skeletal muscle is the type of muscle that we can see and feel. When you work out to increase muscle mass, skeletal muscle is being exercised. Skeletal muscles attach to the skeleton and come in pairs -- one muscle to move the bone in one direction and another to move it back the other way. Increasing skeletal muscle will increase your body's energy requirements. The more muscle you have, the more calories your body will burn. Building skeletal muscle can help prevent "rebound" weight gain. The maintenance and increase of skeletal muscle is closely linked to resting metabolism rate.

### *Interpreting the Skeletal Muscle Percentage Result*

Gender	Age	Low (-)	Normal (0)	High (+)	Very High (++)
Female	18-39	< 24.3	24.3 - 30.3	30.4 - 35.3	$\geq$ 35.4
	40-59	< 24.1	24.1 - 30.1	30.2 - 35.1	$\geq$ 35.2
	60-80	< 23.9	23.9 - 29.9	30.0 - 34.9	$\geq$ 35.0
Male	18-39	< 33.3	33.3 - 39.3	39.4 - 44.0	$\geq$ 44.1
	40-59	< 33.1	33.1 - 39.1	39.2 - 43.8	$\geq$ 43.9
	60-80	< 32.9	32.9 - 38.9	39.0 - 43.6	$\geq$ 43.7

Source: Omron Healthcare

## BODY AGE

Body age is based on your resting metabolism. Body age is calculated by using your weight, body fat percentage and skeletal muscle percentage to produce a guide to whether your body age is above or below the average for your actual age.

# INFORMATION ON BODY COMPOSITION

## ⚠️ WARNING

Contact your physician or healthcare provider before beginning a weight reduction or exercise program.

## LONG-TERM PLANNING FOR SUCCESSFUL WEIGHT LOSS

There are lots of reasons for people to lose weight. To be healthier. To look better. To feel better. To have more energy.

No matter what the reason, successful weight loss and healthy weight management depend on sensible goals and expectations. If you set sensible goals for yourself, chances are you'll be more likely to meet them and have a better chance of keeping the weight off.

The foundation of a successful weight loss program remains a combination of a healthy diet and exercise customized for you. Simply reducing food intake to lose weight can lead to a decline in muscle mass and bone density. So even though your weight goes down, your resting metabolism is reduced making the body more prone to putting on fat. More skeletal muscle can prevent “rebound” weight gain.

The Omron Full Body Sensor Body Composition Monitor and Scale tracks your progress by monitoring weight, skeletal muscle, body fat, BMI and resting metabolism rate to help you reach your goals.

Here’s a comparison of losing weight quickly versus slowly:

Example comparing the same loss of 20 lb:

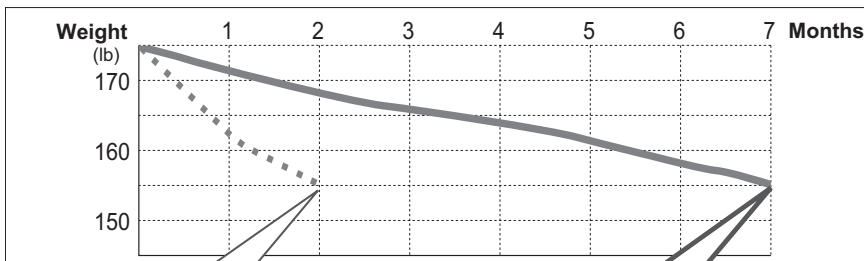

**A starvation diet produces rapid weight loss of 20 lb, but disrupts body mass...**

- Fat reduction: 6 lb
- Lean body mass reduction (muscle, bone, etc.): 14 lb

---

**Change in body fat percentage**

Body fat percentage

Before diet: **36.0%**

After diet: **36.9%**

Lean body mass (muscle, bone, etc.) greatly reduced, while the body fat percentage has not changed.

**A healthy diet with weight loss of 20 lb...**

- Fat reduction: 18 lb
- Lean body mass reduction (muscle, bone, etc.): 2 lb

---

**Change in body fat percentage**

Body fat percentage

Before diet: **36.0%**

After diet: **28.3%**

Body fat percentage reduced to a normal level.

# INFORMATION ON BODY COMPOSITION

## RECOMMENDED MEASUREMENT TIMES

Being aware of the times when the body fat percentages shift within your daily schedule will assist you in obtaining an accurate trending of your body composition. It is recommended to use this unit in the same environment and daily circumstances. Reference the chart below:

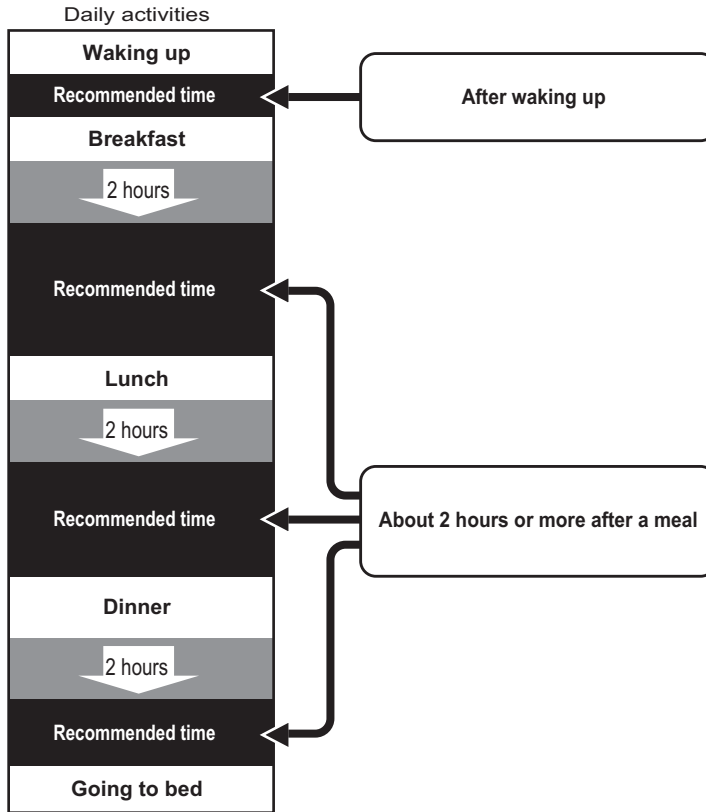

### ***Avoid Taking Measurements Under the Following Conditions:***

- Immediately after vigorous exercise, after a bath or sauna.
  - After drinking alcohol or a large amount of water, after a meal (about 2 hours).
- If a measurement is taken under these physical conditions, the calculated body composition may differ significantly from the actual one because the water content in the body is changing.



# INFORMATION ON BODY COMPOSITION

## ***Results may differ from actual body fat percentage***

There are certain conditions when significant differences may occur between the estimated and the actual body fat values. These differences may be related to changing ratios of body fluid and/or body composition.

The body fat percentage measured by this monitor may significantly differ from the actual body fat percentage for the following people:

- Elderly people
- People with a fever
- Body builders or highly trained athletes
- Persons undergoing dialysis
- Persons with osteoporosis who have very low bone density
- Persons with edema (swelling in the body)
- Children in growth stage

# KNOW YOUR UNIT

## Display Unit

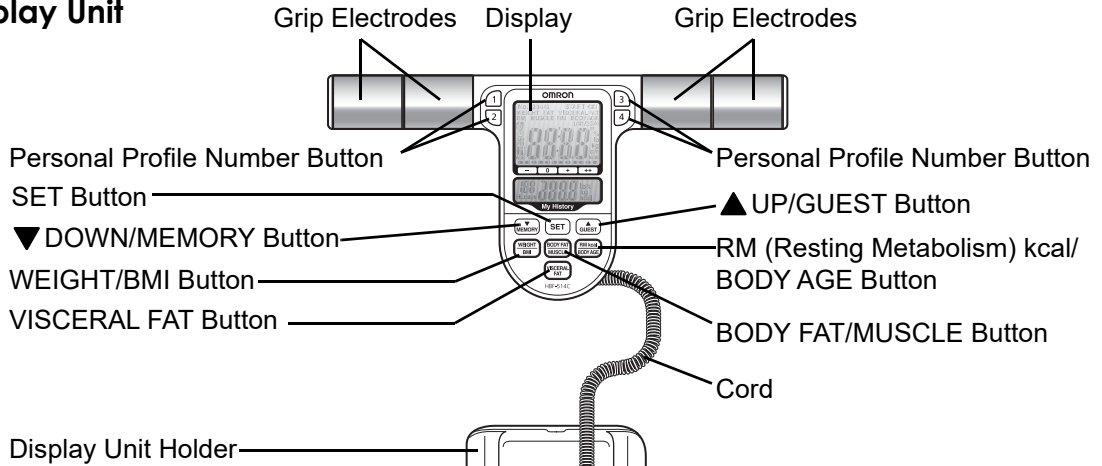

## Main Unit (Measurement Platform)

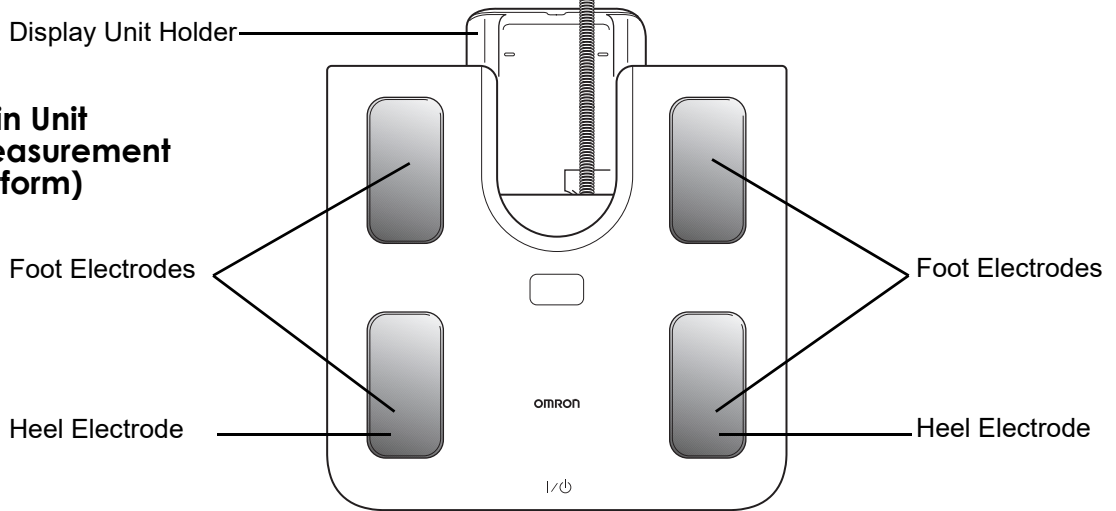

## Front View

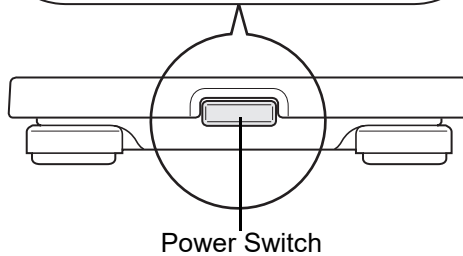

## Components

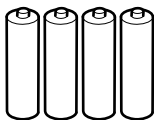

Four AA Batteries



Instruction Manual

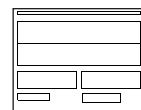

Measurement Log Sheet

# KNOW YOUR UNIT

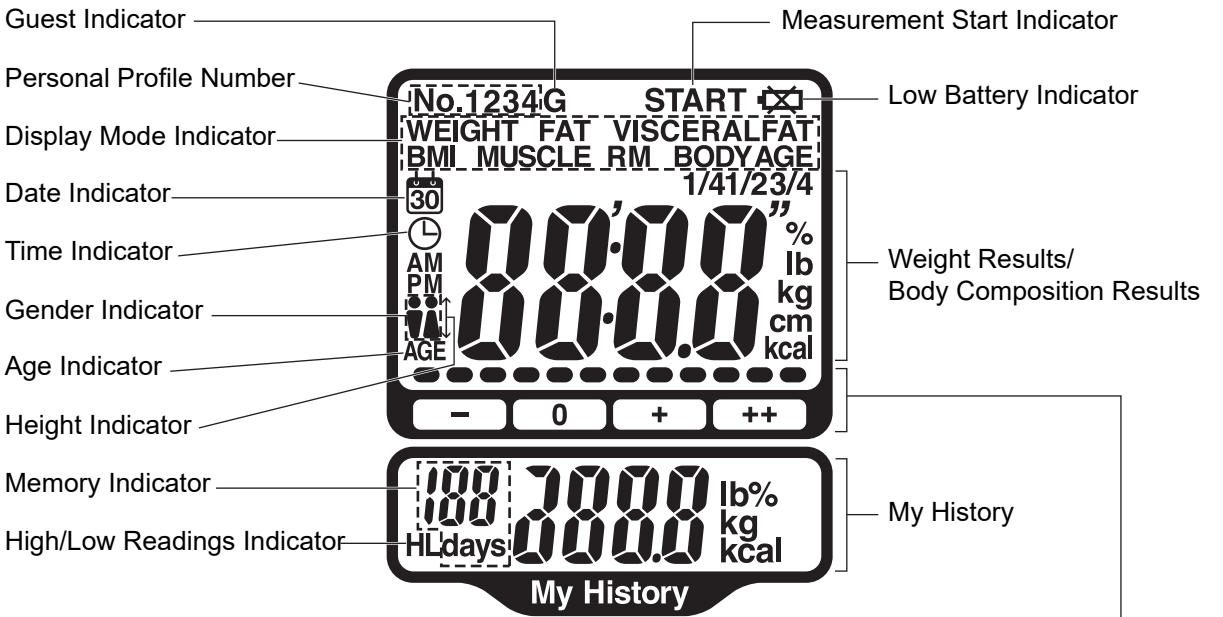

Measurement Progress/Body Fat Percentage, Skeletal Muscle Percentage, Visceral Fat Level and BMI Classification Bar



# KNOW YOUR UNIT

## USING THE DISPLAY UNIT

1. Remove the Display Unit from the Display Unit Holder on the monitor.

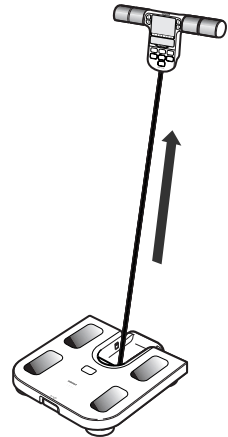

2. To store the cord into the Display Unit Holder, make sure the cord is coiled evenly, and does not stick out of the Display Unit Holder.

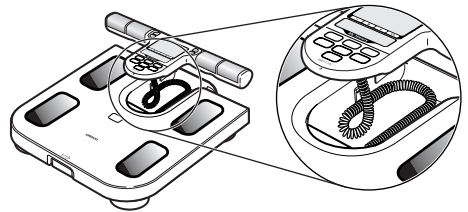

3. Place the Display Unit into the Display Unit Holder.

The display unit will click into place.

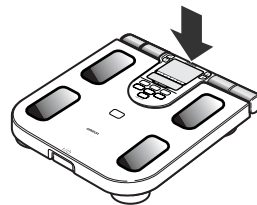

## POWER SWITCH

The power switch is located at the front of the monitor. Press the power switch to turn the monitor on and off.

The power will automatically switch off in the following conditions:

1. If the monitor is not used within one minute of 0.0 lb appearing on the display.
2. If no information is entered for five minutes when entering personal data.
3. If the monitor is not used for five minutes after the measurement results are displayed.
4. Five minutes after the result is displayed when measuring weight only.

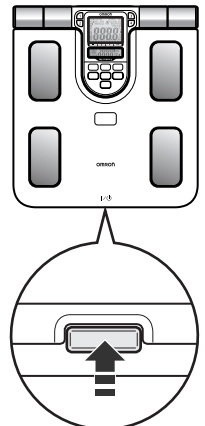

# BATTERY INSTALLATION

## 1. Locate the Battery Cover on the back of the unit.

- 1) Press the tab on the battery cover in the direction of the arrow to release the cover as illustrated.
- 2) Pull the tab of the cover upwards.

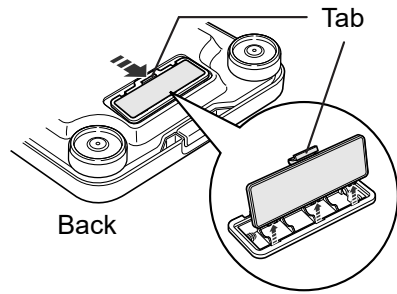

## 2. Install 4 “AA” size batteries so the + (positive) and – (negative) polarities match the polarities of the battery compartment as indicated in the battery compartment.

For both the top row and the bottom row, slide the first battery into the battery compartment before inserting the second battery.

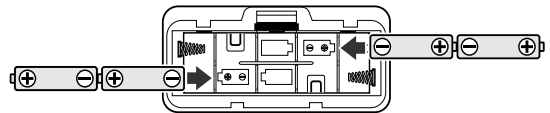

## 3. Replace the battery cover.

- 1) Align the hooks on the battery cover with the slots in the battery compartment.
- 2) Push the battery cover until the tab clicks into place.

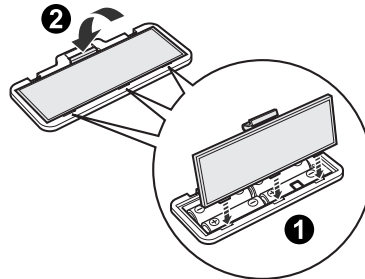

# BATTERY INSTALLATION

## BATTERY REPLACEMENT

Measurement values and personal profiles stored in the memory will not be deleted during battery replacement. However, the date and time will need to be set when monitor is turned back on.

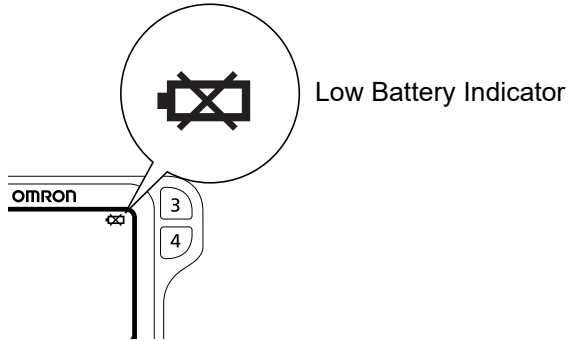

When the Low Battery Indicator appears on the display screen, remove all four batteries. Replace with four new batteries at the same time.

### NOTES:

- New batteries will last for approximately one year if the unit is used four times per day. Trial batteries supplied with the unit may have a shorter life.
- Remove the batteries if you do not intend to use the unit for a period of three months or longer before placing in storage.

### **⚠ CAUTION:**

Should battery fluid leak and contact your eyes, skin or clothing immediately rinse with plenty of clean water. Immediately contact your physician in case of eye or skin contact.

### **⚠ CAUTION:**

Dispose of the device, batteries, components and optional accessories according to applicable local regulations. Unlawful disposal may cause environmental pollution.

# SETTING THE DATE AND TIME

## Buttons Used in this Procedure

### SET Button

Use this button to confirm the setting or move to the next item after confirming the set item.

### ▼ DOWN/MEMORY Button

Press this button to go back one. Press continuously to rapidly decrease.

### ▲ UP/GUEST Button

Press this button to advance one. Press continuously to rapidly advance.

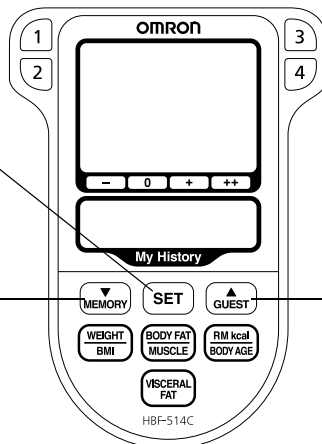

## 1. Press the Power Switch to turn the monitor ON.

If this is the first time that the monitor has been turned on, the year setting flashes.

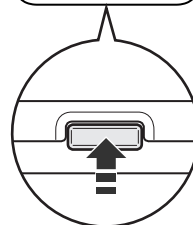
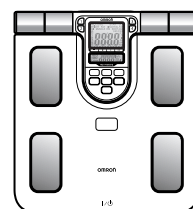

## 2. **SETTING THE YEAR**

- 1) Press the ▲ UP or ▼ DOWN button to change the year.
- 2) Press the SET button.

The year is set.

The month flashes on the display.

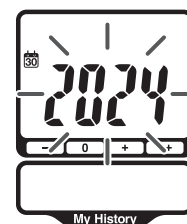

## 3. **SETTING THE MONTH**

- 1) Press the ▲ UP or ▼ DOWN button to change the month.
- 2) Press the SET button.

The month is set.

The day flashes on the display.

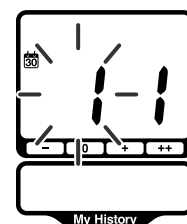

# SETTING THE DATE AND TIME

## 4. SETTING THE DAY

- 1) Press the ▲UP or ▼DOWN button to change the day.
- 2) Press the SET button.

The day is set.  
The hour flashes on the display.

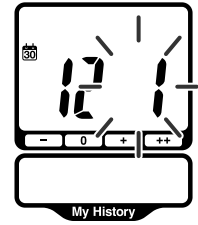

## 5. SETTING THE HOUR

- 1) Press the ▲UP or ▼DOWN button to change the hour.  
Make sure AM/PM is correct.
- 2) Press the SET button.

The hour is set.  
The minute flashes on the display.

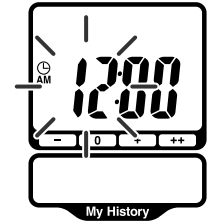

## 6. SETTING THE MINTUTE

- 1) Press the ▲UP or ▼DOWN button to change the minute.
- 2) Press the SET button.

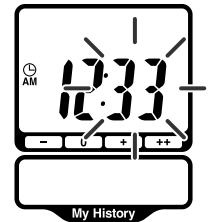

The current settings for the year, month and day, hour and minute appear in this sequence on the display. The monitor automatically turns off.

## TO ADJUST THE DATE AND TIME

- 1) Turn the monitor on.  
The CAL symbol blinks on the display, then the display changes to 0.0 lb. Wait until 0.0 lb appears on the display.
- 2) Press and hold the SET button.  
The year flashes on the display.
- 3) Refer to SETTING THE DATE AND TIME on pages 20 and 21.

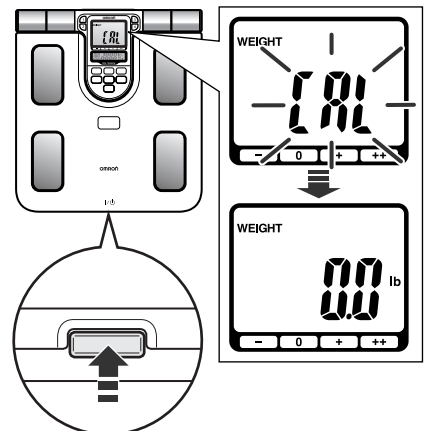

# SETTING PERSONAL DATA

To measure Body Composition, your personal data must be set. Your personal data includes your age, gender and height. The Full Body Sensor Body Composition Monitor and Scale provides two options to enter your personal data.

- 1) Select a personal profile number to save your personal data. The monitor saves up to 4 personal profiles. Select a number 1 through 4. Use this number to enter your personal data when taking a measurement.
- 2) Select ▲ UP/GUEST button if you do not want your personal data stored in the memory. When you use the Guest mode you will need to enter your personal data each time you take a measurement. Measurement results are not stored in the memory when the Guest mode is used.

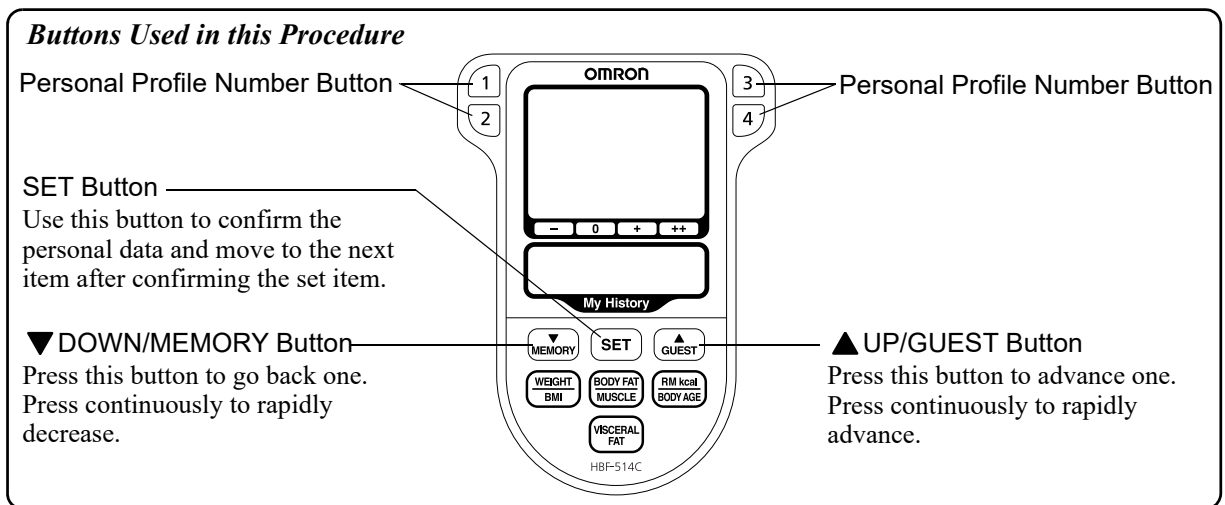

## 1. Press the Power Switch to turn the monitor ON.

The CAL symbol blinks on the display, then the display changes to 0.0 lb.  
Wait until 0.0 lb appears on the display.

## 2. Lift the Display Unit out of the Display Unit Holder.

**NOTE:** This monitor can be set to either the US or Metric System. Personal Profile and memory will be displayed by selected system. To change the US/Metric mode:

- 1) Press and hold the ▼ DOWN/MEMORY button until “lb” and “kg” blink on the display.

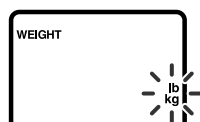

- 2) Press the ▼ DOWN/MEMORY button to select the mode, “lb” or “kg”. This will automatically change “cm” and “feet/inch” under height setting.
- 3) Press the SET button to confirm the change.

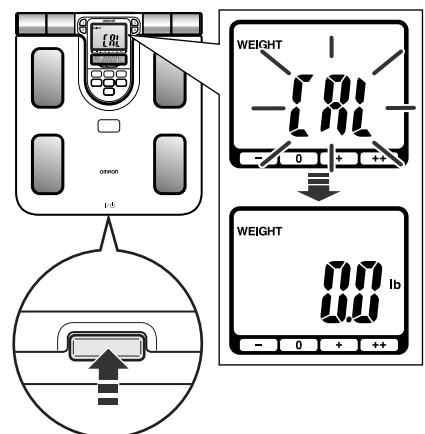

# SETTING PERSONAL DATA

## 3. Select a Personal Profile Number or the Guest mode.

### A. Personal Profile Number

- 1) Press the desired Personal Profile Number button (1 through 4).
- 2) Press the SET button.

#### NOTES:

- If no information has been entered for the Personal Profile Number you selected, the number and the symbols for gender, age and height blink on the display.
- If the personal data has been entered for the number, the Personal Profile Number blinks on the display.

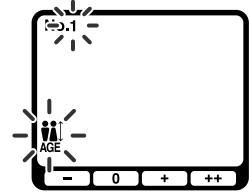

### B. Guest mode

Press the ▲ UP/GUEST button.  
The Guest indicator appears.

The default value for age blinks on the display.

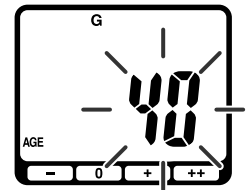

## 4. Enter your Personal Data.

### **SETTING THE AGE**

Set the age between 10 and 80.

- 1) Press the ▲ UP or ▼ DOWN button to change the age.

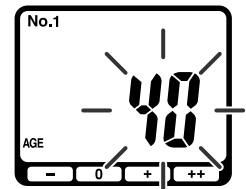

- 2) Press the SET button.

The age is set.

The gender symbols blink on the display.

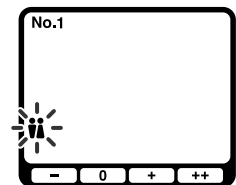

# SETTING PERSONAL DATA

## SETTING THE GENDER

Set the gender to  male or  female.

- 1) Press the **▲UP** or **▼DOWN** button to change the gender.

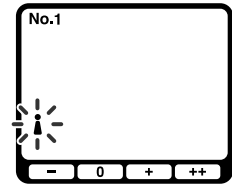

- 2) Press the **SET** button.

The gender is set.

The default value for height blinks on the display.

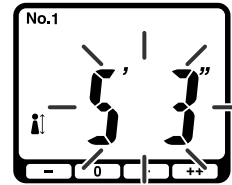

## SETTING THE HEIGHT

Set the height between 3' 4" and 6' 6 3/4".

(Display range in metric display mode: 100.0 cm to 199.5 cm)

- 1) Press the **▲UP** or **▼DOWN** button to change the height.

- 2) Press the **SET** button.

The height is set.

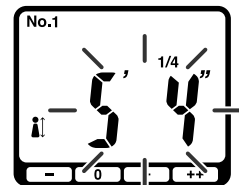

The current settings for age, gender and height appear in this sequence on the display.

The 0.0 lb symbol appears on the display. You can now take a measurement using the Personal Profile Number you selected or the Guest mode.

Refer to HOW TO TAKE A MEASUREMENT on pages 26 to 30.

## CHANGING PERSONAL DATA

If your personal data changes, the information in the Personal Profile Number you selected must be changed for measurement results to be calculated correctly.

1. Press the **Power Switch** to turn the monitor **ON**.

The CAL symbol blinks on the display, then the display changes to 0.0 lb.

Wait until 0.0 lb appears on the display.



# SETTING PERSONAL DATA

## 2. Select the Personal Profile Number you want to change.

- 1) Press the Personal Profile Number button (1 through 4).  
The selected Personal Profile Number flashes once on the display.
- 2) Press the SET button.  
The Personal Profile Number is set.  
The current setting for age blinks on the display.

## 3. Refer to Step 4 on pages 23 and 24 to enter your personal data.

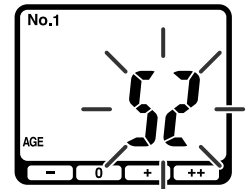

## DELETING PERSONAL DATA

### 1. Press the Power Switch to turn the monitor ON.

The CAL symbol blinks on the display, then the display changes to 0.0 lb. Wait until 0.0 lb appears on the display.

### 2. Select the Personal Profile Number you want to delete.

- 1) Press the Personal Profile Number button (1 through 4).  
The selected Personal Profile Number flashes once on the display.
- 2) Press the SET button.  
The Personal Profile Number is confirmed and the selected age setting blinks on the display.

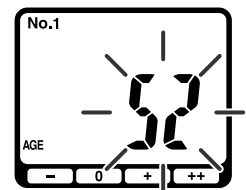

### 3. Press the Personal Profile Number button again for 2 seconds.

The personal data and measurement values are deleted from the memory. The Clr symbol appears on the display followed by the Personal Profile Number and the symbols for gender, age and height as illustrated below.

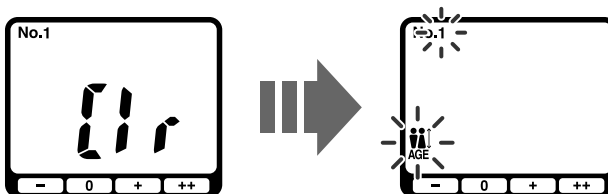

### 4. Refer to Step 3 and 4 on pages 23 and 24 to set the new personal data or press the Power Switch to turn the monitor off.

# HOW TO TAKE A MEASUREMENT

Your personal data must be entered before taking a measurement.

## ⚠ CAUTION:

Persons with disabilities or persons that are physically frail should be assisted by another person when using this monitor or use a handrail, a walker, or other support device to prevent falling when stepping on and off the monitor.

## CORRECT POSTURE FOR MEASUREMENT



After you measure your weight.

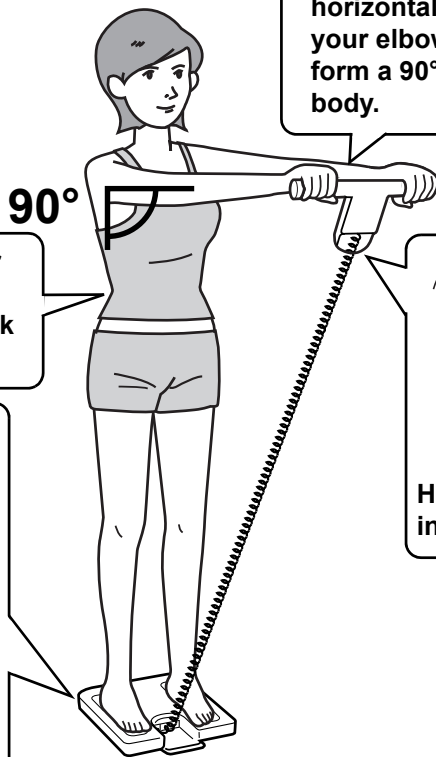

Raise your arms horizontally and extend your elbows straight to form a 90° angle to your body.

90°

Stand with your knees and back straight and look straight ahead.



Hold the display unit in front of you.

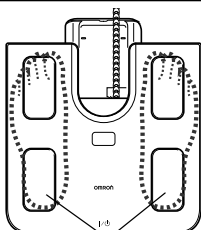

Heel Electrodes

### Step on the Main Unit barefoot.

Make sure your heels are positioned on a heel electrode.  
Stand with your weight evenly distributed on the measurement platform.

## POSTURES TO AVOID DURING MEASUREMENT

Incorrect posture may result in inaccurate measurement of Body Composition.



Movement during measurement



Arms bent

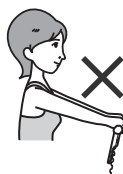

Arms too low or high



Display facing upwards

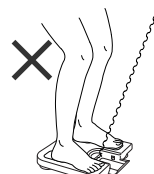

Knees bent

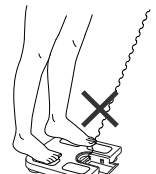

Standing on edge of monitor

# HOW TO TAKE A MEASUREMENT

## HOW TO MEASURE BODY COMPOSITION

### 1. Press the Power Switch to turn the monitor ON.

The CAL symbol blinks on the display, then the display changes to 0.0 lb.

Wait until 0.0 lb appears on the display.

#### NOTES:

- If you step onto the monitor before 0.0 lb appears on the display, an error message “Err” will appear.
- This monitor can be set to either the US or Metric System. Personal Profile and memory will be displayed by selected system. To change the US/Metric mode:

- 1) Keep the ▼DOWN/MEMORY button pressed until “lb” and “kg” blink on the display.



- 2) Press the ▼DOWN/MEMORY button to select the mode, “lb” or “kg”. This will automatically change “cm” and “feet/inch” under height setting.
- 3) Press the SET button to confirm the change.

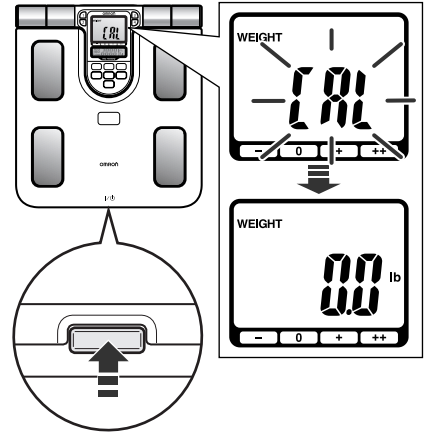

### 2. When the 0.0 lb appears on the display, lift the Display Unit out of the Display Unit Holder.

**NOTE:** Do not take out the display unit until 0.0 lb appears on the display.

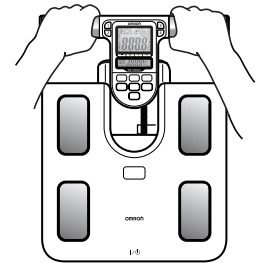

### How to Hold the Grip Electrodes

Press your palms firmly on the grip electrodes.

Place both middle fingers along the dents of the grip electrodes.

Hold the inner grip electrodes firmly with your thumb and index finger.

Hold the outer grip electrodes with your ring finger and small finger.

# HOW TO TAKE A MEASUREMENT

## 3. Select a Personal Profile Number or the Guest mode.

### A. Personal Profile Number

Press the button for the Personal Profile Number you selected while holding the display unit. The Personal Profile Number selected will blink once.

Ex.: To select Personal Profile Number “1”, press button .

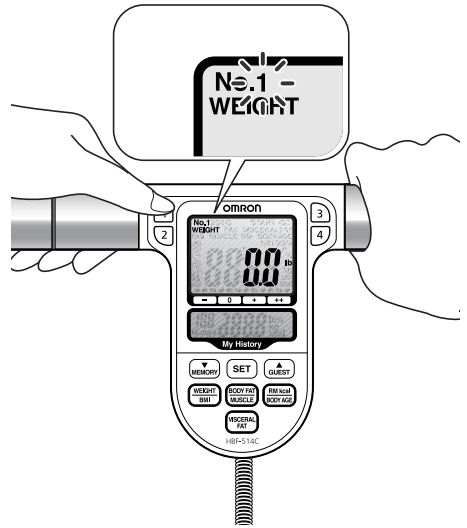

**NOTE:** If the following appears on the display, no personal data was entered for the number you selected.  
Refer to **SETTING PERSONAL DATA** on pages 23 and 24.

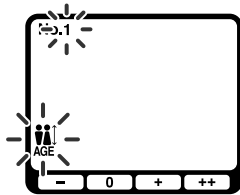

### B. Guest mode

- 1) Press the  while holding the Display Unit.  
“G” will be indicated at the top of the display while “AGE” data flashes.
- 2) Enter your personal data. Refer to **SETTING PERSONAL DATA** on pages 23 and 24.

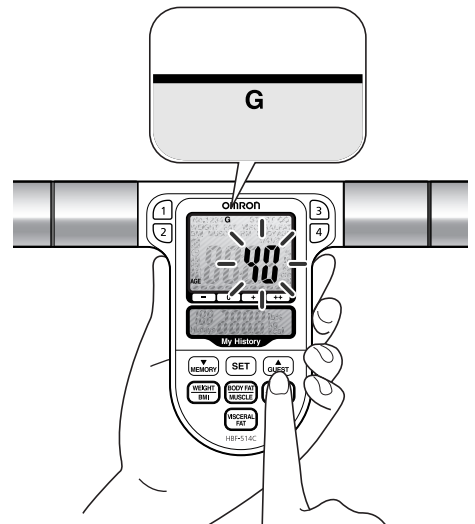

# HOW TO TAKE A MEASUREMENT

## 4. Start the measurement.

- Step onto the measurement platform and place your feet on the foot electrodes with your weight evenly distributed.  
Remain still and do not move until your weight measurement is complete.

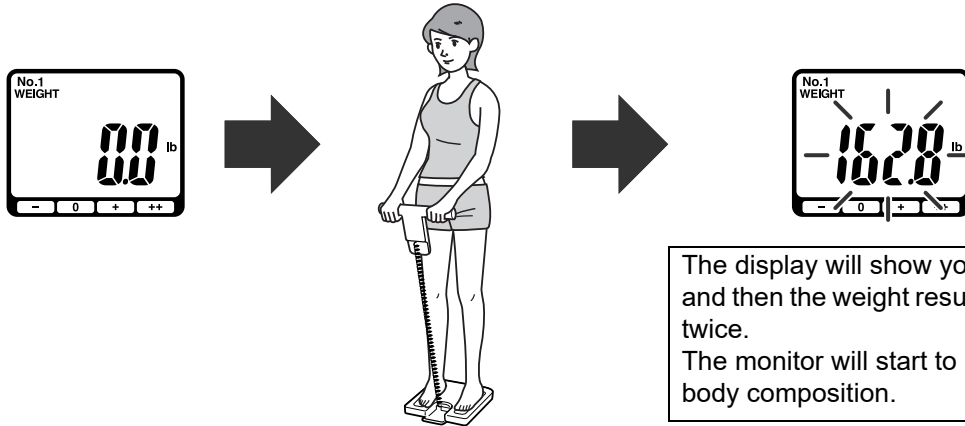

The display will show your weight and then the weight result will blink twice. The monitor will start to calculate body composition.

- When “START” appears on the display extend your arms straight at a 90° angle to your body.

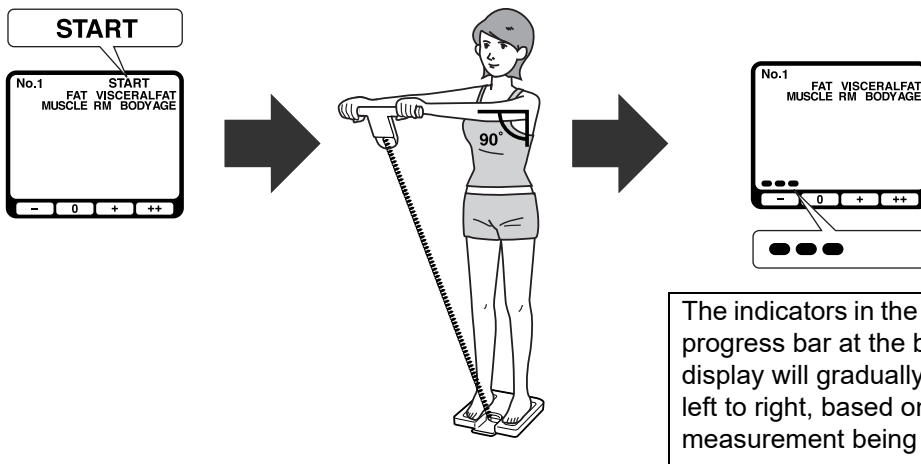

The indicators in the measurement progress bar at the bottom of the display will gradually appear from left to right, based on the measurement being taken.

- When the measurement is completed, your weight is displayed again. Step off the measurement platform. If there is at least one result in memory, the high reading is displayed in the My History area of the display.



**NOTE:** If there are no results in memory, “- - - -” is displayed.

# HOW TO TAKE A MEASUREMENT

## 5. Press the appropriate button to check the measurement results.

For each measurement result, the high reading in memory for that measurement and the number of days ago for that result are shown in the My History area of the display.

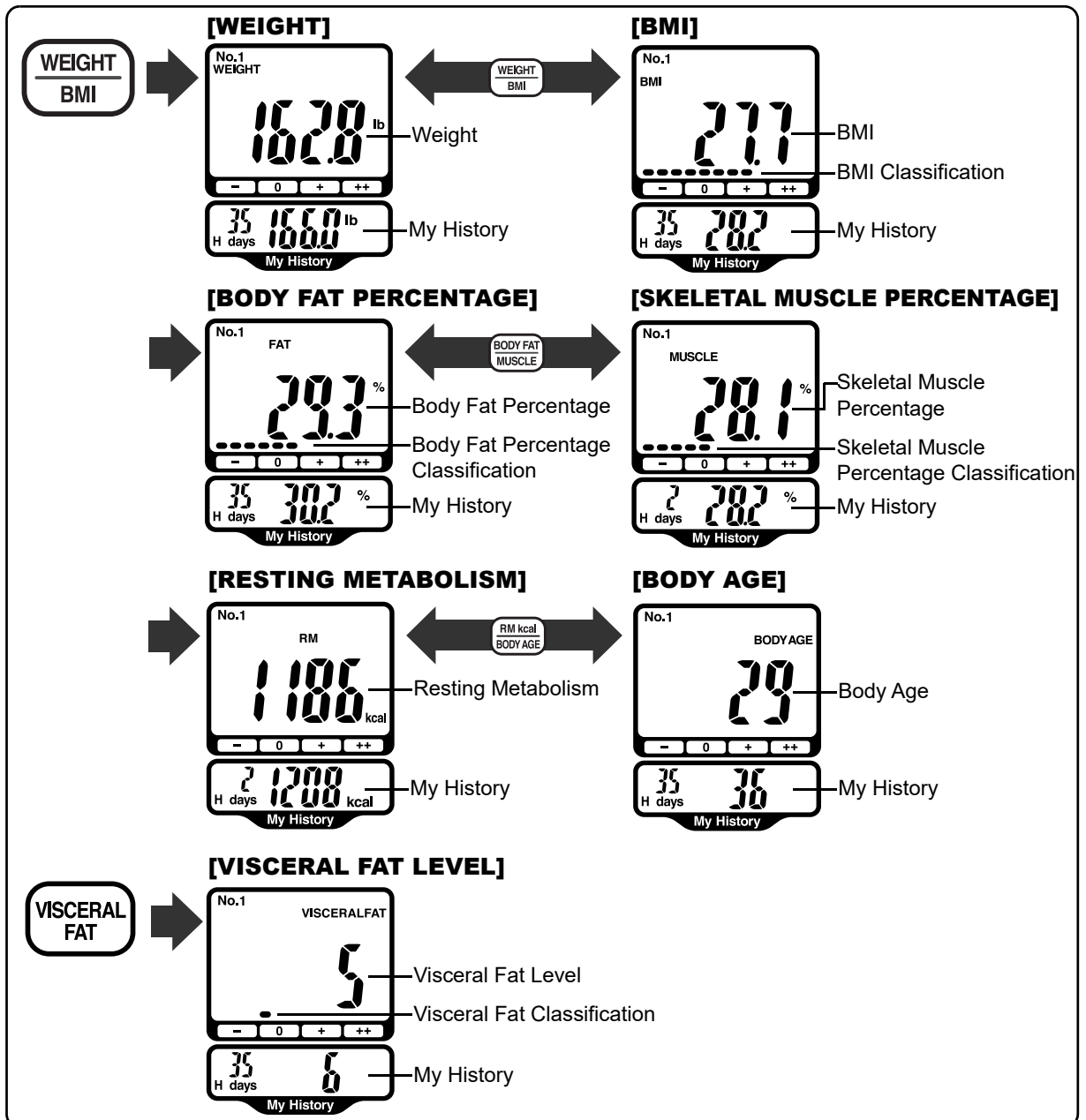

### NOTES:

- The age range for the skeletal muscle percentage, resting metabolism, body age and visceral fat level is 18 to 80 years old.
- The age range for the body fat percentage classification is 20 to 79 years old.

## 6. Press the Power Switch to turn the monitor off. Store the Display Unit in the Display Unit Holder.

# UNDERSTANDING YOUR MEASUREMENT RESULTS

## Interpreting the BMI Result

BMI	BMI (Designation by the WHO)	BMI Classification Bar				BMI Rating
		-	0	+	++	
Less than 18.5	- (Underweight)	███				7.0 - 10.7 10.8 - 14.5 14.6 - 18.4
18.5 or more and less than 25	0 (Normal)	█████	███			18.5 - 20.5 20.6 - 22.7 22.8 - 24.9
25 or more and less than 30	+ (Overweight)	██████████	██████	███		25.0 - 26.5 26.6 - 28.2 28.3 - 29.9
30 or more	++ (Obese)	██████████████	██████████	██████	███	30.0 - 34.9 35.0 - 39.9 40.0 - 90.0

Source: Values for obesity judgment proposed by WHO, the World Health Organization.

## Interpreting the Body Fat Percentage Result

Gender	Age	Low (-)	Normal (0)	High (+)	Very High (++)
Female	20-39	< 21.0	21.0 - 32.9	33.0 - 38.9	≥ 39.0
	40-59	< 23.0	23.0 - 33.9	34.0 - 39.9	≥ 40.0
	60-79	< 24.0	24.0 - 35.9	36.0 - 41.9	≥ 42.0
Male	20-39	< 8.0	8.0 - 19.9	20.0 - 24.9	≥ 25.0
	40-59	< 11.0	11.0 - 21.9	22.0 - 27.9	≥ 28.0
	60-79	< 13.0	13.0 - 24.9	25.0 - 29.9	≥ 30.0

Source: NIH/WHO guidelines for BMI

Source: Gallagher et al., American Journal of Clinical Nutrition, Vol. 72, Sept. 2000

## Interpreting the Skeletal Muscle Percentage Result

Gender	Age	Low (-)	Normal (0)	High (+)	Very High (++)
Female	18-39	< 24.3	24.3 - 30.3	30.4 - 35.3	≥ 35.4
	40-59	< 24.1	24.1 - 30.1	30.2 - 35.1	≥ 35.2
	60-80	< 23.9	23.9 - 29.9	30.0 - 34.9	≥ 35.0
Male	18-39	< 33.3	33.3 - 39.3	39.4 - 44.0	≥ 44.1
	40-59	< 33.1	33.1 - 39.1	39.2 - 43.8	≥ 43.9
	60-80	< 32.9	32.9 - 38.9	39.0 - 43.6	≥ 43.7

Source: Omron Healthcare

## Interpreting the Visceral Fat Level Result

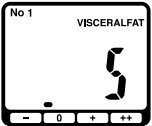
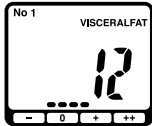
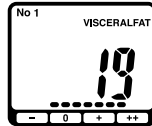
 <p>Visceral Fat Level ≤ 9</p>	 <p>10 ≤ Visceral Fat Level ≤ 14</p>	 <p>Visceral Fat Level ≥ 15</p>
0 (Normal)	+ (High)	++ (Very High)

Visceral fat area (0 - approx. 300 cm<sup>2</sup>, 1 inch=2.54 cm) distribution with 30 levels.

Source: Omron Healthcare

**NOTE:** Visceral fat levels are relative and not absolute values.

# HOW TO MEASURE WEIGHT ONLY

## 1. Press the Power Switch to turn the monitor ON.

The CAL symbol blinks on the display, then the display changes to 0.0 lb.

Wait until 0.0 lb appears on the display.

### NOTES:

- If you step onto the monitor before 0.0 lb appears on the display, an error message “Err” will appear.
- This monitor can be set to either the US or Metric System. Personal Profile and memory will be displayed by selected system. To change the US/Metric mode:

- 1) Keep the ▼DOWN/MEMORY button pressed until “lb” and “kg” blink on the display.



- 2) Press the ▼DOWN/MEMORY button to select the desired measurement unit, “lb” or “kg”. This will automatically change “cm” and “feet/inch” under height setting.
- 3) Press the SET button to confirm the change.

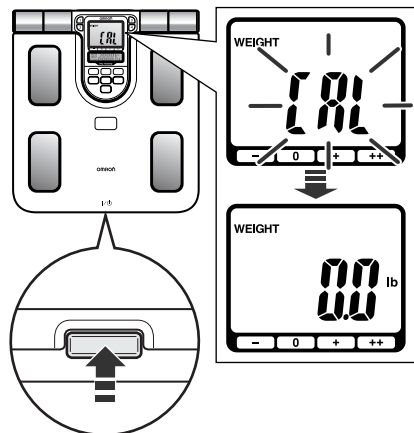

## 2. Step onto the Measurement Platform.

Stand with your weight evenly distributed on the measurement platform.

Remain still and do not move until the measurement is complete.

## 3. Check the measurement result.

The display will show your weight and then the weight result will blink twice.



## 4. Step off the Measurement Platform.

## 5. Press the Power Switch to turn the monitor off.



# HOW TO USE THE MEMORY FUNCTION

Measurement results are automatically stored in memory when you take a measurement using a Personal Profile Number button. You can view results for 1 day, 7, 30 and 90 days ago. The monitor automatically stores measurement readings for up to 97 days for each Personal Profile Number. When 97 days of measurement readings are stored in the memory for that Personal Profile Number, the oldest record is deleted to save the most recent measurement reading.

## NOTES:

- If a measurement was not taken on the exact day for 1 day, 7, 30 and 90 days ago, measurement results stored in the memory as shown in the following chart will display.

1 day ago	Closest data stored from day 2 to day 6
7 days ago	Closest data stored from day 8 to day 14
30 days ago	Closest data stored from day 31 to day 37
90 days ago	Closest data stored from day 91 to day 97

- Only one set of measurement results is stored for each Personal Profile Number each day. If more than one measurement is taken during a day, the results from the last measurement are stored.

## High/Low Readings

The unit displays high (H) and low (L) readings for each measurement result and the number of days ago for that result. This can be between 1 day ago and 97 days ago. If there is no memory value, “- - -” is displayed.

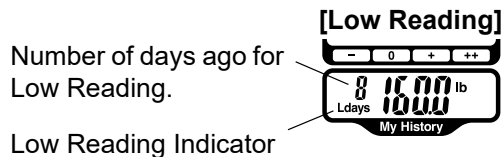
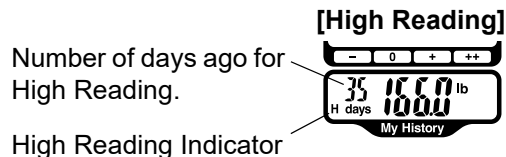

## NOTES:

- If there is more than one day with results equal to high/low readings, then the most recent result is used.
- If there is only a measurement result in the memory, then high/low readings are the same.

# HOW TO USE THE MEMORY FUNCTION

## Buttons Used in this Procedure

Personal Profile Number Button

Personal Profile Number Button

### ▼ DOWN/MEMORY Button

Press this button to view previous results for 1 day, 7 days, 30 days and 90 days ago with high/low readings.

WEIGHT/BMI Button

VISCERAL FAT Button

BODY FAT/MUSCLE Button

RM kcal/BODY AGE Button

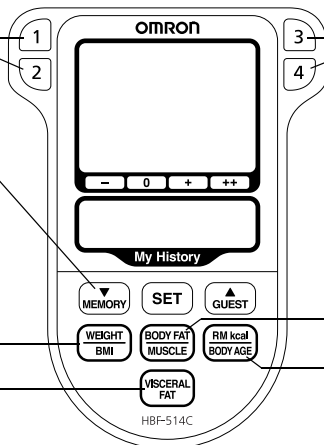

## Comparing Results After Taking a Measurement

### 1. View the measurement results after taking a measurement.

Press the ▼ DOWN/MEMORY button to cycle through the results from high (H) reading, low (L) reading, “1 day”, “7 days”, “30 days” and “90 days” ago.

High Reading

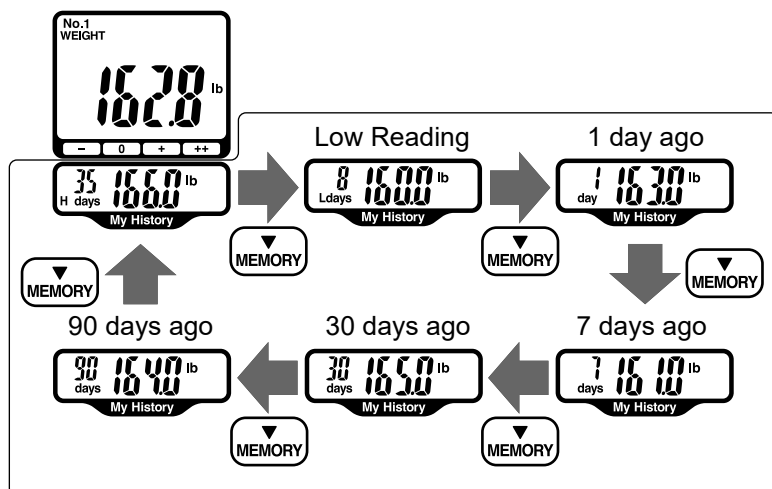

### NOTES:

- If there are no results for a selected memory, “- - - -” is displayed for that item.

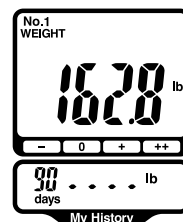

# HOW TO USE THE MEMORY FUNCTION

- To view previous results for other items, press the button for the desired item. The results for the selected item are displayed.
- Then press the ▼DOWN/MEMORY button to cycle through the previous results for that item.

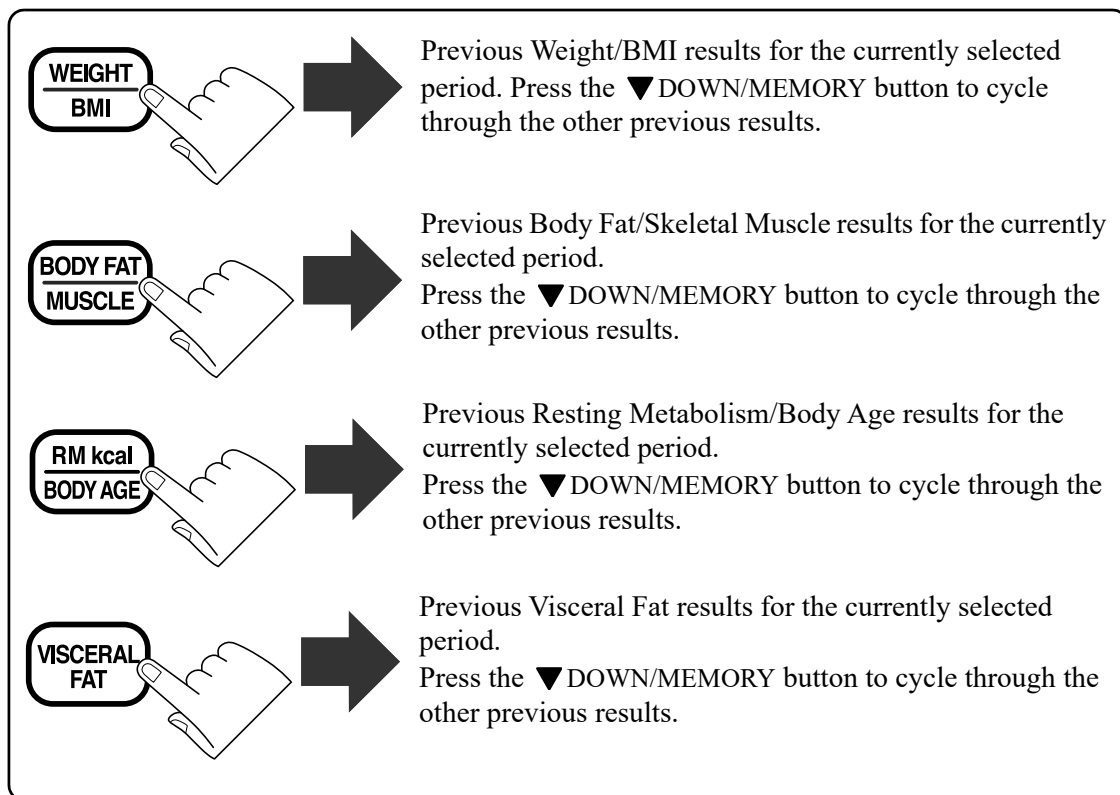

## 2. Press the Power Switch to turn the monitor off.

# HOW TO USE THE MEMORY FUNCTION

## Viewing Previous Measurement Results

Follow this process if you want to view and compare previous measurement results without taking a measurement.

### 1. Press the Power Switch to turn the monitor ON.

The CAL symbol blinks on the display, then the display changes to 0.0 lb.

Wait until 0.0 lb appears on the display.

**NOTE:** If you step onto the measurement platform before 0.0 lb appears on the display, an error message “Err” will appear.

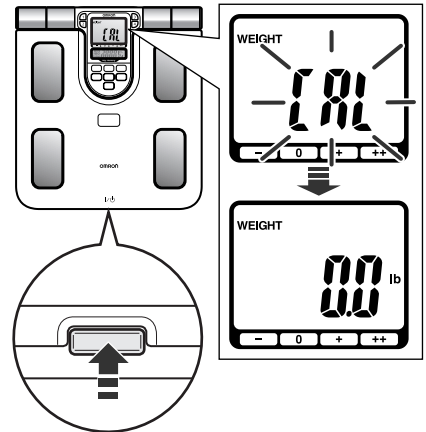

### 2. When the 0.0 lb appears on the display, lift the Display Unit out of the Display Unit Holder.

**NOTE:** Do not take out the display unit until 0.0 lb appears on the display.

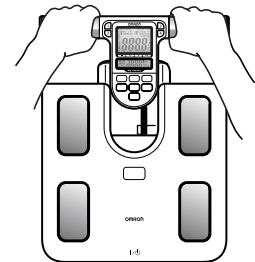

### 3. Press the desired Personal Profile Number button.

Ex.: To select Personal Profile Number “1”, press button **1**.

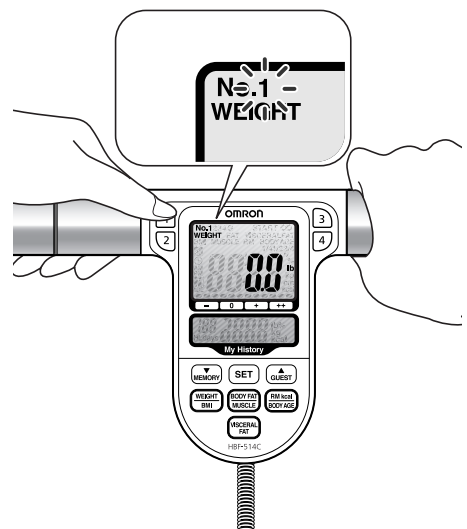

# HOW TO USE THE MEMORY FUNCTION

## 4. View previous measurement results.

- 1) Press the ▼DOWN/MEMORY button once.  
The result for the high reading in memory is shown in the My History area of the display.

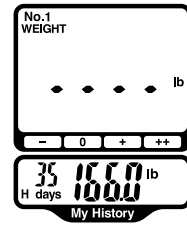

- 2) Press the ▼DOWN/MEMORY button to cycle through the results from high (H) reading, low (L) reading, “1 day”, “7 days”, “30 days” and “90 days” ago.



**NOTE:** To view previous results for BMI, body fat, skeletal muscle, resting metabolism, body age and visceral fat, press the button for the desired measurement. The results for the selected item are displayed. (Refer to page 35.)

## 5. Press the Power Switch to turn the monitor off.

# ERROR INDICATORS

ERROR DISPLAY	CAUSE	CORRECTION
{rr1}	Your palms or feet are not positioned over the electrodes correctly.	Make sure you are barefoot. Make sure your palms or the soles of your feet are clean and dry. Make sure your palms or feet are correctly positioned. Refer to CORRECT POSTURE FOR MEASUREMENT on page 26 and How to Hold the Grip Electrodes on page 27.
{rr2}	The measurement position was not stable. Your palms or feet were not placed correctly.	Remain still and do not move until the measurement is complete. Refer to CORRECT POSTURE FOR MEASUREMENT on page 26 and How to Hold the Grip Electrodes on page 27.
{rr3}	Your palms or feet are too dry.	Slightly moisten your palms or the soles of your feet with a damp towel and retake the measurement.
{rr4}	The Body Composition values are outside the measurement range.	<ul style="list-style-type: none"> <li>• Check the settings entered for your personal data. Change the settings if needed. Retake the measurement.</li> <li>• The main unit cannot measure body composition outside its measurement range, even if the age, gender and height settings are correct. Refer to Display and Set Ranges on page 43.</li> </ul>
{rr5}	The monitor is not set up correctly.	Remove the batteries. Wait one minute. Reinstall the batteries. Refer to BATTERY INSTALLATION on page 18. Press the Power Switch and turn the monitor on. Retake the measurement.
{rr}	You stepped onto the measurement platform before 0.0 lb was displayed.	Wait until 0.0 lb is displayed before stepping onto the measurement platform.
	The monitor was moved before 0.0 lb was displayed.	Do not move the monitor until 0.0 lb is displayed.
	Movement during measurement.	Do not move until measurement is complete.
	Monitor detected weight over 330.0 lb.	This monitor can only be used by people weighing less than 330.0 lb.

# TROUBLESHOOTING TIPS

PROBLEM	CAUSE AND SOLUTION
Low Battery Indicator No power No display appears on the unit	Check the battery installation for proper placement of the battery polarities. Replace all four worn batteries.
Measurement does not start.	The memory data is being updated. (“  ” appears in the lower area of the display.) Wait one minute, then try again.
Measurement results are slow to appear.	If you take a measurement when the date will change during the course of the measurement, it may take longer than normal for the measurement results to be displayed. (“  ” appears in the lower area of the display.) Wait for the results to be displayed.
The weight value is displayed abnormally low or high.	Place the monitor on a hard and level floor.
The Body Composition value is displayed abnormally low or high.	Refer to RECOMMENDED MEASUREMENT TIMES on pages 13 and 14. Check the settings entered for your personal data.
Other conditions	Remove the batteries. Wait one minute. Reinstall the batteries. Refer to BATTERY INSTALLATION on page 18.

# CARE AND MAINTENANCE

To keep your Full Body Sensor Body Composition Monitor and Scale in the best condition and protect the monitor from damage follow the directions below:

**Clean the monitor with a soft dry cloth.** Do not use abrasive or volatile cleaners. The monitor is not waterproof.

**Store the monitor in a safe and dry location.** Do not expose the monitor to direct sunlight, extreme hot or cold temperatures or humidity. Thoroughly dry any moisture off the monitor before storing.

**⚠ CAUTION:**

Do not submerge the device or any of the components in water.

**⚠ CAUTION:**

Do not subject the monitor to strong shocks, such as dropping the unit on the floor.

**Remove the batteries** if the monitor will not be used for three months or longer.

**Store the Display Unit in the Main Unit** as shown in the figure.

As you place the lower portion of the Display Unit, it clicks and fits into the Display Unit Holder.

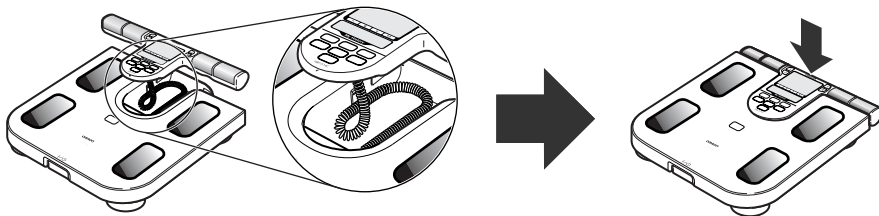

**Do not crease the cord** when storing in the Display Unit Holder.

**Use the monitor consistent with the instruction provided in this manual.**

**⚠ CAUTION:**

Do not disassemble or modify the unit. Changes or modifications not approved by Omron Healthcare will void the user warranty.



# FCC STATEMENT

## **NOTE:**

### POTENTIAL FOR RADIO/TELEVISION INTERFERENCE (for U.S.A. only)

This product has been tested and found to comply with the limits for a Class B digital device, pursuant to part 15 of the FCC rules.

These limits are designed to provide reasonable protection against harmful interference in a residential installation. The product generates, uses, and can radiate radio frequency energy and, if not installed and used in accordance with the instructions, may cause harmful interference to radio communications. However, there is no guarantee that interference will not occur in a particular installation. If the product does cause harmful interference to radio or television reception, which can be determined by turning the product on and off, the user is encouraged to try to correct the interference by one or more of the following measures:

- Reorient or relocate the receiving antenna.
- Increase the separation between the product and the receiver.
- Connect the product into an outlet on a circuit different from that to which the receiver is connected.
- Consult the dealer or an experienced radio/TV technician for help.

### POTENTIAL FOR RADIO/TELEVISION INTERFERENCE

(for Canada only)

This digital apparatus does not exceed the Class B limits for radio noise emissions from digital apparatus as set out in the interference-causing equipment standard entitled “Digital Apparatus”, ICES-003 of the Canadian Department of Communications.

Cet appareil numérique respecte les limites de bruits radioélectriques applicables aux appareils numériques de Classe B prescrites dans la norme sur le matériel brouilleur: “Appareils Numériques”, ICES-003 édictée par le ministère des communications.

Changes or modifications not expressly approved by the party responsible for compliance could void the user’s authority to operate the equipment.

# WARRANTY

## Limited Warranty

Your HBF-514C Full Body Sensor Body Composition Monitor and Scale, excluding the batteries, is warranted to be free from defects in materials and workmanship appearing within 1 year from the date of purchase, when used in accordance with the instructions provided with the unit. The above warranties extend only to the original retail purchaser.

We will, at our option, repair or replace without charge any monitor covered by the above warranties. Repair or replacement is our only responsibility and your only remedy under the above warranties. To obtain warranty service contact Omron Healthcare's Customer Service by calling 1-800-634-4350 for the address of the repair location and the return shipping and handling fee. Information for warranty service is available on our website at [www.omronhealthcare.com](http://www.omronhealthcare.com).

Enclose the Proof of Purchase. Include a letter, with your name, address, phone number, and description of the specific problem. Pack the product carefully to prevent damage in transit. Because of possible loss in transit, we recommend insuring the product with return receipt requested.

**ALL IMPLIED WARRANTIES, INCLUDING BUT NOT LIMITED TO THE IMPLIED WARRANTIES OF MERCHANTABILITY AND FITNESS FOR PARTICULAR PURPOSE, ARE LIMITED TO THE DURATION OF THE APPLICABLE WRITTEN WARRANTY ABOVE.** Some states do not allow limitations on how long an implied warranty lasts, so the above limitation may not apply to you.

**OMRON SHALL NOT BE LIABLE FOR LOSS OF USE OR ANY OTHER INCIDENTAL, CONSEQUENTIAL OR INDIRECT COSTS, EXPENSES OR DAMAGES.** Some states do not allow the exclusion or limitation of incidental or consequential damages, so the above exclusions may not apply to you. This warranty gives you specific legal rights, and you may also have other rights which may vary from state to state.

### FOR CUSTOMER SERVICE

Visit our web site at:  
Call toll free:

[www.omronhealthcare.com](http://www.omronhealthcare.com)  
1-800-634-4350

# SPECIFICATIONS

Model	OMRON Full Body Sensor Body Composition Monitor and Scale - HBF-514C
Display	<p><b>Body Weight:</b> 0 to 330 lb with 0.2 lb increments (0 to 150 kg with 0.1 kg increments)</p> <p><b>Body fat percentage:</b> 5.0 to 60.0% with 0.1% increments</p> <p><b>Skeletal muscle percentage:</b> 5.0 to 50.0% with 0.1% increments</p> <p><b>BMI:</b> 7.0 to 90.0 with 0.1 increments</p> <p><b>Resting metabolism:</b> 385 to 3999 kcal with 1 kcal increments</p> <p><b>Body age:</b> 18 to 80 years old with 1 year increments</p> <p><b>Visceral fat level:</b> 30 levels with 1 level increments</p> <p><b>BMI classification:</b> – (Underweight) / 0 (Normal) / + (Overweight) / ++ (Obese) with 12 levels of Bar display</p> <p><b>Body fat percentage and Skeletal muscle percentage classification:</b> – (Low) / 0 (Normal) / + (High) / ++ (Very High) with 12 levels of Bar display</p> <p><b>Visceral fat classification:</b> 0 (Normal) / + (High) / ++ (Very High) with 9 levels of Bar display</p> <p><b>Memory:</b> 1 day, 7 days, 30 days, 90 days ago with high/low readings based on up to 97 days results.</p> <p>* The age range for the skeletal muscle percentage, resting metabolism, body age and visceral fat level is 18 to 80 years old.</p> <p>* The age range for the body fat percentage classification is 20 to 79 years old.</p>
Set Ranges	<p><b>Height:</b> 3' 4" to 6' 6 3/4" (100.0 to 199.5 cm)</p> <p><b>Age:</b> 10 to 80 years old</p> <p><b>Gender:</b> Male/Female</p>
Power Supply	4 AA batteries
Battery Life	Approximately 1 year (when used four times a day)
Operating Temperature /Humidity	+50°F to +104°F (+10°C to +40°C), 30 to 85% RH
Storage Temperature /Humidity/Air Pressure	–4°F to +140°F (–20°C to +60°C), 10 to 95% RH, 700 - 1060 hPa
External Dimensions	<p><b>Display Unit:</b> Approximately 11 3/4" (W) x 1 3/8" (H) x 5 3/4" (D)</p> <p><b>Main Unit:</b> Approximately 11 7/8" (W) x 2 1/8" (H) x 12 7/8" (D)</p>
Weight	Approximately 4 5/8 lb (including batteries)
Durable Period	5 years
Contents	Monitor/Scale, 4 AA Batteries, Instruction Manual, Measurement Log Sheet
UPC Code	0 73796 26514 4

**NOTE:** Specifications are subject to change without prior notice.

Manufactured for :  
OMRON HEALTHCARE Co., Ltd.  
Distributed by :  
**OMRON HEALTHCARE, INC.**  
2895 Greenspoint Pkwy.  
Hoffman Estates, IL 60169 USA

[www.omronhealthcare.com](http://www.omronhealthcare.com)  
© 2024 OMRON HEALTHCARE, INC.

Made in China

1665708-0F