



Complete™
Blood Pressure Monitor + EKG
Model BP7900
Instruction Manual

Table of Contents

Introduction	2	10. Maintenance	47
Safety Instructions	2	10.1 Maintenance	47
Intended Use	3	10.2 Storage	47
Receiving and Inspection	3	10.3 Cleaning	48
Symbols Glossary	3	10.4 Disposal	48
Important Safety Information	4	11. Optional Accessories	49
1. Know Your Monitor	9	12. Specifications	50
1.1 Contents	9	13. FCC Statement	53
1.2 Monitor and Arm Cuff	9	14. Limited Warranty	54
1.3 BP Reading Display and Symbols on the Monitor	10	15. Guidance and Manufacturer’s Declaration	55
1.4 Classification of BP (Blood Pressure)	12		
1.5 Reading Your EKG Result	13		
1.6 Distinction between Pulse Rate and Heart Rate	17		
2. Preparation	18		
2.1 Installing Batteries	18		
2.2 Pairing Your Monitor with a Smartphone	20		
2.3 Blood Pressure Measurement/EKG Recording Tips	23		
3. Taking a Blood Pressure Measurement and Recording an EKG	24		
3.1 Applying the Arm Cuff	24		
3.2 Sitting Correctly	26		
3.3 Taking a Blood Pressure Measurement and Recording an EKG	27		
4. Taking Only a Blood Pressure Measurement	33		
5. Recording Only an EKG	35		
6. Transfer Your Blood Pressure Readings Manually	38		
7. Taking a Blood Pressure Measurement Manually	39		
8. Other Settings on the Monitor	40		
8.1 Disabling/Enabling Bluetooth	40		
8.2 Restoring Your Monitor to the Default Settings	41		
9. Error Messages and Troubleshooting	42		

Introduction

Thank you for purchasing the OMRON BP7900 Blood Pressure Monitor + EKG.

This monitor has 2 main features; a blood pressure measurement and an electrocardiogram (EKG or ECG) recording.

There are 3 ways to use this monitor: measuring blood pressure only; EKG only; blood pressure and EKG simultaneously.

Visit the “Support” section in the “OMRON connect US/CAN” app for additional information about using the app.

Blood pressure measurement

This monitor uses the oscillometric method of blood pressure measurement. This means this monitor detects your blood movement through your brachial artery and converts the movements into a digital reading.

Electrocardiogram (EKG or ECG) recording

This model also has a clinical-quality EKG recorder which allows users to record and display EKGs on their smartphones with the “OMRON connect US/CAN” app.

The “OMRON connect US/CAN” app also provides instant analysis of the recorded EKG to evaluate whether the heart rhythm is normal or if possible atrial fibrillation, bradycardia and tachycardia are detected.

EKG software and services powered by AliveCor

Safety Instructions

This instruction manual provides you with important information about the OMRON BP7900 Blood Pressure Monitor + EKG. To ensure the safe and proper use of this monitor, READ and UNDERSTAND all of these instructions. **If you do not understand these instructions or have any questions, contact 1-800-634-4350 before attempting to use this monitor. For specific information about your own blood pressure and heart related conditions, consult with your physician.**

Introduction

Intended Use

The device is intended to measure blood pressure only, electrocardiogram (ECG) only or blood pressure and ECG simultaneously.

The device is a digital monitor intended for use in measuring blood pressure and pulse rate in adult population.

The device is intended to record, store, and transfer single-channel electrocardiogram (ECG) rhythms. The device also displays ECG rhythms and detects the presence of atrial fibrillation, bradycardia, tachycardia and normal sinus rhythm (when prescribed or used under the care of a physician). The device is intended for use by healthcare professionals, patients with known or suspected heart conditions, and health-conscious individuals. The device has not been tested and it is not intended for pediatric use.

Receiving and Inspection

Remove this monitor and other components from the packaging and inspect for damage. If this monitor or any other components are damaged, DO NOT USE and contact 1-800-634-4350.

Symbols Glossary

For symbol information, visit: OmronHealthcare.com/symbols-glossary

Contraindications

- This monitor is contraindicated for use in ambulatory environments.
 - This monitor is contraindicated for use on aircraft.
-

Important Safety Information

Read the Important Safety Information in this instruction manual before using this monitor.

Follow this instruction manual thoroughly for your safety.

Keep for future reference. For specific information about your own blood pressure and heart related conditions, CONSULT WITH YOUR PHYSICIAN.

⚠ Warning Indicates a potentially hazardous situation which, if not avoided, could result in death or serious injury.

- DO NOT use this monitor on infants, toddlers, children or persons who cannot express themselves.
- DO NOT adjust medication based on readings from this blood pressure monitor and/or EKG recordings. Take medication as prescribed by your physician. ONLY a physician is qualified to diagnose and treat high blood pressure and other heart related conditions.
- DO NOT use this monitor on an injured arm/fingers or an arm/fingers under medical treatment.
- DO NOT apply the arm cuff on your arm while on an intravenous drip or blood transfusion.
- DO NOT use this monitor in areas containing high frequency (HF) surgical equipment, magnetic resonance imaging (MRI) equipment, computerized tomography (CT) scanners. This may result in incorrect operation of the monitor and/or cause an inaccurate blood pressure readings and/or EKG recordings.
- DO NOT use this monitor in oxygen rich environments or near flammable gas.
- Consult with your physician before using this monitor if you have common arrhythmias such as atrial or ventricular premature beats or atrial fibrillation; arterial sclerosis; poor perfusion; diabetes; pregnancy; pre-eclampsia or renal disease.
NOTE that any of these conditions in addition to patient motion, trembling, or shivering may affect the blood pressure readings and/or EKG recordings.
- NEVER diagnose or treat yourself based on your blood pressure readings and/or EKG recordings. ALWAYS consult with your physician.
- To help avoid strangulation, keep the air tube away from infants, toddlers and children.
- Keep components out of the reach of infants, toddlers and children.
This product contains small parts that may cause a choking hazard if swallowed by infants, toddlers and children.
- DO NOT record an EKG with a cardiac pacemaker, Implantable Cardioverter Defibrillators, or other implanted electronic devices.

Important Safety Information

Data Transmission

- This product emits radio frequencies (RF) in the 2.4 GHz band. DO NOT use this product in locations where RF is restricted, such as on an aircraft or in hospitals.
Turn off the **Bluetooth**® feature in this monitor, remove batteries when in RF restricted areas. For further information on potential restrictions refer to documentation on the Bluetooth usage by the FCC.

Battery Handling and Usage

- Keep batteries out of the reach of infants, toddlers and children.

 **Caution** Indicates a potentially hazardous situation which, if not avoided, may result in minor or moderate injury to the user or patient, or cause damage to the equipment or other property.

- Stop using this monitor and consult with your physician if you experience skin irritation or discomfort.
- Consult with your physician before using this monitor on an arm where intravascular access or therapy, or an arterio-venous (A-V) shunt, is present because of temporary interference to blood flow which could result in injury.
- Consult with your physician before using this monitor if you have had a mastectomy.
- Consult with your physician before using this monitor if you have severe blood flow problems or blood disorders as cuff inflation can cause bruising.
- DO NOT take blood pressure measurements more often than necessary because bruising, due to blood flow interference, may occur.
- ONLY inflate the arm cuff when it is applied on your upper arm.
- Remove the arm cuff if it does not start deflating during a blood pressure measurement.
- DO NOT use this monitor for any purpose other than measuring blood pressure, heart rate and heart rhythm.
- During a blood pressure measurement and/or an EKG recording, make sure that no mobile device or any other electrical device that emits electromagnetic fields, other than the smartphone to be used with the monitor, is within 12 inches (30 cm) of this monitor. This may result in incorrect operation of the monitor and/or cause inaccurate blood pressure readings and/or EKG recordings.
- DO NOT disassemble or attempt to repair this monitor or other components. This may cause inaccurate blood pressure readings and/or EKG recordings.

Important Safety Information

- DO NOT use in a location where there is moisture or a risk of water splashing this monitor. This may damage this monitor.
- DO NOT use this monitor in a moving vehicle such as a car or during physical activity.
- DO NOT drop or subject this monitor to strong shocks or vibrations.
- DO NOT use or store this monitor in places with high or low humidity, high or low temperatures or in bright and sunny environments. Refer to section 12.
- Ensure this monitor is not impairing blood circulation by observing the arm while blood pressure measurement is occurring.
- DO NOT use this monitor in high-use environments such as medical clinics or physician offices.
- DO NOT use this monitor with other medical electrical (ME) equipment simultaneously. This may result in incorrect operation of the monitor and/or cause an inaccurate blood pressure readings and/or EKG recordings.
- Avoid bathing, drinking alcohol or caffeine, smoking, exercising and eating for at least 30 minutes before taking a blood pressure measurement.
- Rest for at least 5 minutes before taking a blood pressure measurement.
- Remove tight-fitting and thick clothing from your arm while taking a blood pressure measurement.
- Remain still and DO NOT talk while taking a blood pressure measurement.
- Remain still while recording an EKG.
- ONLY use the arm cuff on persons whose arm circumference is within the specified range of the cuff.
- Ensure that this monitor has acclimated to room temperature before taking a blood pressure measurement and/or recording an EKG. Taking a blood pressure measurement and/or recording an EKG after an extreme temperature change could lead to an inaccurate blood pressure readings and/or EKG recordings. OMRON recommends waiting for approximately 2 hours for the monitor to warm up or cool down when the monitor is used in an environment within the temperature specified as operating conditions after it is stored either at the maximum or at the minimum storage temperature. For additional information of operating and storage/transport temperature, refer to section 12.
- DO NOT use this monitor after the durable period has ended. Refer to section 12.
- DO NOT crease the arm cuff or the air tube excessively.
- DO NOT fold or kink the air tube while taking a blood pressure measurement. This may cause an injury by interrupting blood flow.
- To unplug the air plug, pull on the plastic air plug at the base of the tube, not the tube itself.
- ONLY use the approved arm cuff for this monitor. Use of other arm cuffs may result in incorrect blood pressure readings.

Important Safety Information

- Inflating to a higher pressure than necessary may result in bruising of the arm where the cuff is applied.
NOTE: please refer to section 7 for taking a blood pressure measurement manually.
- ONLY use the arm cuff, batteries and accessories specified for this monitor. Use of unsupported arm cuffs and batteries may damage and/or may be hazardous to this monitor.
- The use of accessories and cables other than those specified or provided by OMRON could result in increased electromagnetic emission or decreased electromagnetic immunity of the monitor and result in improper operation.
- During a blood pressure measurement and/or an EKG recording, the use of the monitor adjacent to or stacked with another device, other than the smartphone to be used with the monitor, should be avoided because it could result in improper operation. In case such use is necessary, the monitor and the other device should be observed to verify that they are operating normally.
- OMRON makes no warranty for any data or information that is collected erroneously by the monitor, or misuse or malfunction as a result of abuse, accidents, alteration, misuse, neglect, or failure to maintain the product as instructed.
- Interpretations made by this monitor are potential findings, not a complete diagnosis of cardiac conditions. All interpretations should be reviewed by a medical professional for clinical decision-making.
- DO NOT use this monitor in the presence of flammable anesthetics or drugs.
- DO NOT expose this monitor to strong electromagnetic fields.
- DO NOT use this monitor while charging your smartphone.
- DO NOT record an EKG during cautery and external defibrillation procedures.
- DO NOT record an EKG in close vicinity to other equipment emitting acoustic sound.
- DO NOT record an EKG if the electrodes are dirty. Clean them first.
- After EKG analysis, the app may incorrectly identify ventricular flutter, ventricular bigeminy, and ventricular trigeminy heart conditions as unreadable. Consult with your physician.
- OMRON does not guarantee that you are not experiencing an arrhythmia or other health conditions when labeling an EKG as normal. You should notify your physician for possible changes in your health.
- If the “OMRON connect US/CAN” app detects possible atrial fibrillation in an EKG, consult with your physician before making any medical decision, including altering your use of any drug or treatment.
- The atrial fibrillation detector evaluates for possible atrial fibrillation ONLY. It will NOT detect other potentially life threatening arrhythmias, and it is possible that other cardiac arrhythmias may be present.

Important Safety Information

- The atrial fibrillation detector ONLY evaluates for possible atrial fibrillation after you have recorded an EKG. It does NOT continuously monitor your heart and therefore cannot alert you if atrial fibrillation happens at any other time.
- Result of “Bradycardia” or “Tachycardia” are designations of heart rate, not a clinical diagnosis of an actual arrhythmia. Consult with your physician.
- When your fingertips are dry, your EKG recording may not be successful. If dry, moisten your fingers with a wet towel, a water-based lotion, or something similar.
- DO NOT record an EKG with dirty hands.
- Make sure to place your smartphone on the smartphone stand of the monitor when recording an EKG. If it is not placed appropriately on the smartphone stand, there may be communication issues between the smartphone and the monitor, and your EKG may not be recorded successfully.
- The EKG electrodes should not touch any other conductive parts.
- If you wear hearing aids, turn them off.

Data Transmission

- DO NOT replace batteries while your blood pressure readings are being transferred to your smartphone. This may result in incorrect operation of this monitor and failure to transfer your blood pressure readings.

Battery Handling and Usage

- DO NOT insert batteries with their polarities incorrectly aligned.
- ONLY use 4 “AA” alkaline batteries with this monitor. DO NOT use other types of batteries. DO NOT use new and used batteries together. DO NOT use different brands of batteries together.
- Remove batteries if this monitor will not be used for 3 months or more.
- If battery fluid should get in your eyes, immediately rinse with plenty of clean water. Consult with your physician immediately.
- If battery fluid should get on your skin, wash your skin immediately with plenty of clean, lukewarm water. If irritation, injury or pain persists, consult with your physician.
- DO NOT use batteries after their expiration date.
- Periodically check batteries to ensure they are in good working condition.
- Make sure the battery compartment is securely closed with the battery cover when recording an EKG. If the battery cover is not in place, recording an EKG may not be successful. If you have lost the battery cover, contact customer service.

1. Know Your Monitor

1.1 Contents

Monitor, Wide-Range D-Ring Cuff, storage case, 4 "AA" alkaline batteries, instruction manual, quick start guide.

1.2 Monitor and Arm Cuff

- Ⓐ Smartphone stand
- Ⓑ Top electrodes
- Ⓒ Side electrode (both sides)
- Ⓓ [Connection] button
- Ⓔ BP reading display*
- Ⓕ BP [START/STOP] button*
- Ⓖ Battery compartment
- Ⓗ Air jack
- Ⓘ Arm cuff
(Arm circumference 9" - 17"
(22 - 42 cm))
- ⓰ Air plug
- ⓱ Air tube



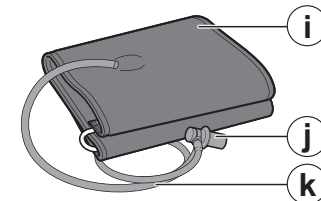
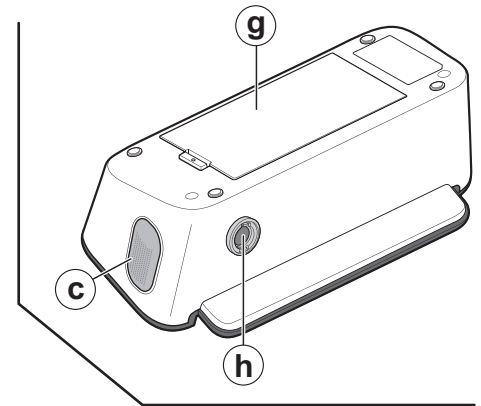
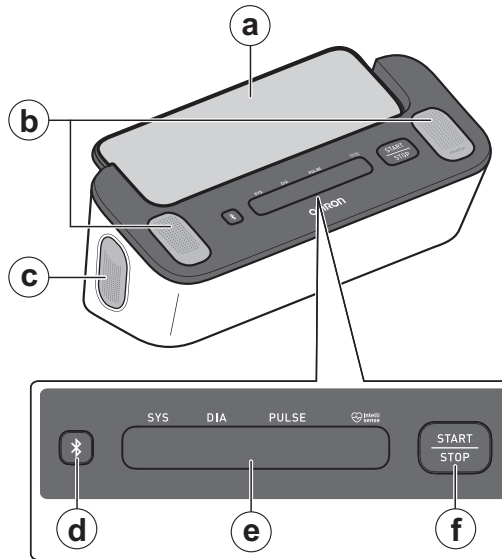

*BP indicates blood pressure.



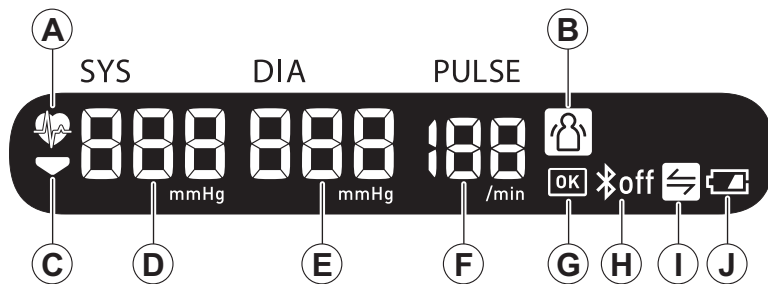



1. Know Your Monitor

1.3 BP Reading Display and Symbols on the Monitor



(A)		Heartbeat symbol Flashes while taking a blood pressure measurement.
(B)		Movement error symbol Appears along with a blood pressure reading when your body is moving during a blood pressure measurement. If it appears, remove the arm cuff, and wait for 2 to 3 minutes. Then, remain still and take another measurement.
(C)		Deflation symbol Appears during cuff deflation.
(D)		Systolic blood pressure reading
(E)		Diastolic blood pressure reading
(F)		Pulse display Pulse rate appears after the blood pressure measurement.
(G)		OK symbol Flashes when your monitor is connected to your smartphone or readings are transferred successfully.

1. Know Your Monitor

Ⓜ		Bluetooth ON symbol Appears when your readings are being transferred.
		Bluetooth OFF symbol Appears when Bluetooth is disabled.
ⓘ		Sync symbol Flashes/appears when your data needs to be transferred because the internal stored blood pressure memory is either almost, or completely full. Once you pair your monitor with your smartphone, transfer your blood pressure readings immediately before the monitor deletes the oldest blood pressure readings. Up to 90 blood pressure readings can be stored in the internal memory of your monitor.
Ⓝ		Low battery symbol Appears when batteries are low.
		Depleted battery symbol Appears when batteries are depleted.

1. Know Your Monitor

1.4 Classification of BP (Blood Pressure)

ACC/AHA 2017 Hypertension guidelines defines categories of BP in adults as below.

Categories of BP in Adults*

BP Category	Systolic BP		Diastolic BP
Normal	<120 mmHg	and	<80 mmHg
Elevated	120 - 129 mmHg	and	<80 mmHg
Hypertension			
Stage 1	130 - 139 mmHg	or	80 - 89 mmHg
Stage 2	≥140 mmHg	or	≥90 mmHg

* Individuals with Systolic BP and Diastolic BP in 2 categories should be designated to the higher BP category. BP indicates blood pressure (based on an average of ≥2 careful readings obtained on ≥2 occasions).

Source: ACC/AHA 2017 High Blood Pressure Clinical Practice Guideline

Warning

-
- NEVER diagnose or treat yourself based on your blood pressure readings and/or EKG recordings. ALWAYS consult with your physician.
-

1. Know Your Monitor

1.5 Reading Your EKG Result

When the EKG recording is finished, the results are displayed on the downloaded “OMRON connect US/CAN” app as: Possible Atrial Fibrillation (or AFib), Bradycardia, Tachycardia, Normal, Unreadable or Unclassified.

The detectors of EKG have been developed and tested on Lead I recordings only.

Note

- You must download and follow up instructions for setting up the app.

Atrial Fibrillation detector

The Atrial Fibrillation detector detects possible atrial fibrillation in an EKG tracing. After you record an EKG, if possible atrial fibrillation is detected you will be notified as Possible Atrial Fibrillation (or AFib) within the app. This finding is not a diagnosis, it is only a potential finding for the recorded EKG. You should contact your physician to review any EKG recording in which possible atrial fibrillation was detected. If you are experiencing any symptoms or concerns contact a medical professional.

Atrial fibrillation means the most common type of non-sinus tachyarrhythmia. In atrial fibrillation, disorganized electrical impulses that originate in the atria and pulmonary veins initiate the electrical activity in the conduction system of the heart. This causes what are commonly termed as “irregularly irregular” heart beats.

When a heart is in atrial fibrillation, its two upper chambers, the right and left atria, essentially quiver instead of beating efficiently.

This does not allow for complete emptying of the atria and thus blood may become stagnant and create blood clots. This can lead to major health problems, including strokes, transient ischemic attacks (TIAs), and pulmonary emboli (PEs); depending which chamber of the heart has the blood clot in it.

Approximately 15 percent of strokes occur in people with atrial fibrillation. As age increases in a population, so too does the incidence of atrial fibrillation, which peaks at about 3-5% in people over the age of 65.

The most common presenting symptoms of atrial fibrillation are palpitations, dizziness, fast heart rate, irregularly irregular rhythm, an abnormal heart sound (S1), chest pain, chronic shortness of breath, abnormal jugular venous pressure,

1. Know Your Monitor

fatigue, and impaired exercise tolerance. Other symptoms related to TIAs and strokes may be the initial symptoms of atrial fibrillation.

Some of the most common causes of atrial fibrillation are long-standing hypertension, congestive heart disease, cardiac valvular lesions, myocardial infarctions, history of coronary artery bypass grafts, hyperthyroidism, alcohol abuse, smoking, diabetes mellitus, and electrolyte imbalances.

Bradycardia detector

Bradycardia detector detects bradycardia, in an EKG tracing.

After you record an EKG, if bradycardia is detected you will be notified as Bradycardia within the app.

Bradycardia means a type of arrhythmia due to slower heart rate (40-50 beats per minute). The app analyzes EKGs to detect normal sinus rhythm without major abnormalities between 40-50 beats per minute.

Tachycardia detector

Tachycardia detector detects tachycardia, in an EKG tracing.

After you record an EKG, if tachycardia is detected you will be notified as Tachycardia within the app.

Tachycardia means a type of arrhythmia due to faster heart rate (100-140 beats per minute). The app detects normal sinus rhythm without major abnormalities at these heart rates.

Normal detector

Normal detector notifies you as Normal within the app, when a EKG recording is normal.

Normal means that the heart rate is between 50 and 100 beats per minute, there are no or very few abnormal beats, and the shape, timing and duration of each beat is considered normal sinus rhythm. It is important to remember that there is a wide range of normal variability among different individuals. Changes in the shape or timing of an EKG might be normal for a single individual, but since the apps are used by a large and diverse population, the Normal detector has been designed to be conservative with what it detects as normal.

1. Know Your Monitor

If you have been diagnosed with a condition that affects the shape of your EKG (e.g., intraventricular conduction delay, left or right bundle branch block, Wolff-Parkinson-White Syndrome, etc.), experience a large number of premature ventricular or atrial contractions (PVC and PAC), are experiencing an arrhythmia, or took a poor-quality recording it is unlikely that you will be notified that your EKG is normal.

It is also important to note that the Normal detector looks at the entire signal before determining if it can be declared to be normal. If you experience a small number of PACs or PVCs in a recording of otherwise normal beats in normal rhythm, the Normal detector will likely declare that EKG recording to be normal.

The Normal detector will not declare an EKG outside the heart rate of 50-100 beats per minute as normal, even if the EKG has normal sinus rhythm. As a result, if you typically get normal results but take an EKG immediately after any physical activity that raises your heart rate above 100 beats per minute, you may not get a normal result.

Unreadable detector

The Unreadable detector determines whether a recording can be accurately interpreted or not. After recording an EKG, if interference is detected you will be notified within the app that your recording has “No analysis” and given some suggestions for acquiring good quality EKG recording. You subsequently have the option to save the recording, or try again. If the recording can be analyzed, the Atrial Fibrillation, Bradycardia, Tachycardia and Normal detectors will run on the EKG and inform you as described previous pages.

Unclassified

The app may display the Unclassified message for an EKG recording that was not detected as Normal, nor as Possible Atrial Fibrillation, nor as Bradycardia, nor as Tachycardia, and not as Unreadable.

Unclassified means the result is not Normal, nor Possible Atrial Fibrillation, nor Bradycardia, nor Tachycardia and not Unreadable.

Unclassified result may be normal rhythms, such as when your heart rate is higher than 100 beats per minute after physical activity, or abnormal rhythms; if you consistently get unclassified results, you may want to share your these EKG recordings with your physician. You can send the recordings by email.

1. Know Your Monitor

Note

- Other than Possible Atrial Fibrillation, Bradycardia, Tachycardia, Normal, Unclassified and Unreadable, EKG error messages may appear on the app due to some reasons such as a shortage of recording time, too noisy to interpret or etc. If it appears, follow the suggestions on the app.

Caution

- After EKG analysis, the app may incorrectly identify ventricular flutter, ventricular bigeminy, and ventricular trigeminy heart conditions as unreadable. Consult with your physician.
 - OMRON does not guarantee that you are not experiencing an arrhythmia or other health conditions when labeling an EKG as normal. You should notify your physician for possible changes in your health.
 - If the “OMRON connect US/CAN” app detects possible atrial fibrillation in an EKG, consult with your physician before making any medical decision, including altering your use of any drug or treatment.
 - The atrial fibrillation detector evaluates for possible atrial fibrillation ONLY. It will NOT detect other potentially life threatening arrhythmias, and it is possible that other cardiac arrhythmias may be present.
 - The atrial fibrillation detector ONLY evaluates for possible atrial fibrillation after you have recorded an EKG. It does NOT continuously monitor your heart and therefore cannot alert you if atrial fibrillation happens at any other time.
 - Result of “Bradycardia” or “Tachycardia” are designations of heart rate, not a clinical diagnosis of an actual arrhythmia. Consult with your physician.
-

1. Know Your Monitor

1.6 Distinction between Pulse Rate and Heart Rate

The pulse rate on blood pressure measurement and the heart rate on EKG recording are calculated differently as follows. There may be a difference between both values.

**Pulse rate on
blood pressure measurements**

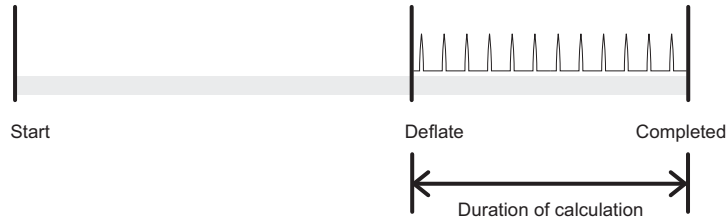

**Heart rate on
EKG recordings**

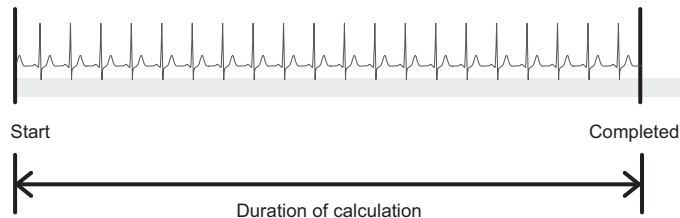

2. Preparation

2.1 Installing Batteries

1. Push down the hole of the battery cover with a thin object such as a pen, and pull the hook upward.

Note

- When using a thin object, be careful not to get yourself injured.

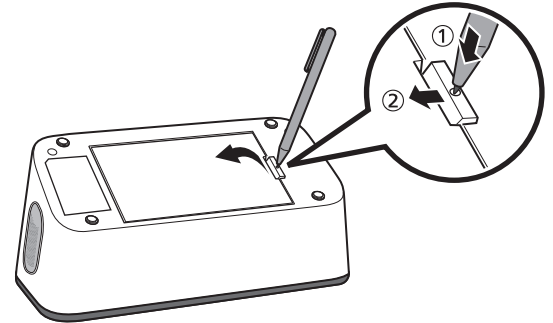

2. Insert 4 “AA” alkaline batteries as indicated in the battery compartment.

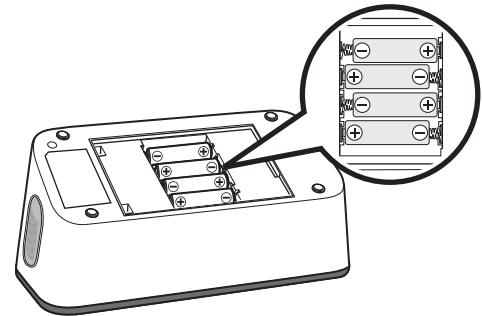

2. Preparation

3. Close the battery cover securely.

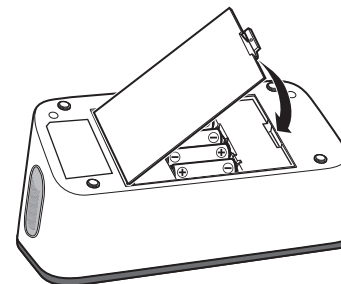

Note

- When the “” symbol appears on the BP reading display, it is recommended you replace batteries.
- To replace batteries, turn your monitor off and remove all batteries. Then replace with 4 new alkaline batteries at the same time.
- Before taking blood pressure measurements, your monitor needs to be set with the correct date and time.
The date and time are automatically set when you pair with and/or transfer your blood pressure readings to your smartphone. However, the date and time will only be set for future blood pressure measurements taken after the blood pressure reading that was transferred, it will not be saved as the blood pressure reading that was just transferred. For pairing or transferring instructions, refer to sub-section 2.2.
- Replacing batteries will not delete previous blood pressure readings.
- The supplied batteries may have a shorter life span than new batteries.
- Disposal of used batteries should be carried out in accordance with local regulations.

Caution

- Make sure the battery compartment is securely closed with the battery cover when recording an EKG. If the battery cover is not in place, recording an EKG may not be successful. If you have lost the battery cover, contact customer service.

2. Preparation

2.2 Pairing Your Monitor with a Smartphone

The date and time on your monitor will automatically be set when you pair your monitor with your smartphone.

Note

- You must download the app and pair it to your smartphone before you can use the EKG function.

Review the list of compatible smartphones at OmronHealthcare.com. Any devices and operating systems not listed on our website are not supported.

1. **Enable Bluetooth on your smartphone.**
2. **Download and install the “OMRON connect US/CAN” app onto your smartphone.**



If you already have this app and have created your account, open the app and add your new monitor. You may use your account to access to view blood pressure readings and/or EKG recordings on the app. You can go back later and edit your information if necessary.

3. **Open the app and follow the pairing instructions shown on your smartphone.**

2. Preparation

4. Confirm that your monitor is connected successfully.

When your monitor is connected successfully to your smartphone, the “OK” symbol flashes.

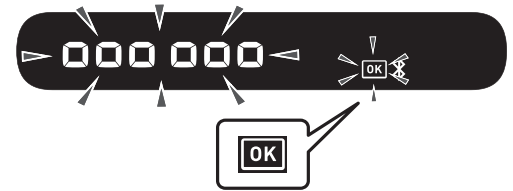

5. Press the BP [START/STOP] button to turn your monitor off.

Note

- Your monitor will automatically turn off after 10 seconds.
- If you do not pair this monitor to set the date and time, any blood pressure readings you take with this monitor will not be transferred.
- Please be aware that OMRON will not be responsible for the loss of data and/or information in the app.
- “OMRON connect US/CAN” is the only app that we recommend to use with your monitor to transfer your blood pressure readings and record and view your EKG results correctly.

2. Preparation

Free medical interpretation of your first EKG recording

A U.S. board-certified cardiologist will automatically review your first EKG recording for free and will provide a medical interpretation within 24 hours. Due to FDA regulations, the heart rhythm for your first recording will not be visible on your smartphone screen and you will not be able to record any additional EKGs while the cardiologist is preparing your report. After you receive your report notification by email, you will be able to view and record your further EKGs.

Referral code (A 12-character code from your physician or a cardiac monitoring service)

This monitor enables users to connect to their physicians with a referral code. If you were prescribed the monitor by your physicians or through cardiac monitoring service, you should have received a 12-character referral code. With the code you can create an account, and you can view from your first EKG.

When paired, the user's EKG recordings are available to be viewed by their physicians.

Note

- Users without a referral code may send their EKG recordings to their physician by emailing the PDF from the “OMRON connect US/CAN” app on the smartphone.

2. Preparation

2.3 Blood Pressure Measurement/EKG Recording Tips

Blood pressure measurement tips to help ensure an accurate reading:

- Stress raises blood pressure. Avoid taking measurements during stressful times.
- Measurements should be taken in a quiet place.
- It is important to take measurements at the same times each day. Taking measurements in the morning and in the evening is recommended.
- Remember to have a record of your blood pressure and pulse readings for your physician. A single measurement does not provide an accurate indication of your true blood pressure. You need to take and record several readings over a period of time.

Caution

-
- Avoid bathing, drinking alcohol or caffeine, smoking, exercising and eating for at least 30 minutes before taking a blood pressure measurement.
 - Rest for at least 5 minutes before taking a blood pressure measurement.
-

EKG recording tips to help ensure an accurate recording:

- Clean the 4 electrodes with alcohol-based sanitizer. Refer to sub-section 10.3.
- Disconnect headphones, charger cables, or any other connected devices from your smartphone.
- We recommend taking resting heart rate EKGs when you first rise in the morning; the time of day when the body is most rested.

3. Taking a Blood Pressure Measurement and Recording an EKG

There are 3 ways to use this monitor.

1. Taking a blood pressure measurement and recording an EKG simultaneously: refer to the steps in this section.
2. Taking only a blood pressure measurement: refer to section 4.
3. Recording only an EKG: refer to section 5.

3.1 Applying the Arm Cuff

Note

- The following steps are for applying the arm cuff to your left arm. When you take a measurement on your right arm, follow the cuff wrap instructions for a right arm use mentioned under “Note” located at the end of this sub-section.
- The blood pressure can differ between the right arm and the left arm, and the measured blood pressure readings can be different. OMRON recommends to always use the same arm for measurement. If the blood pressure readings between both arms differ substantially, check with your physician to determine as to which arm to use for your measurements.

Caution

- Remove tight-fitting and thick clothing from your arm while taking a measurement.

1. **Plug the arm cuff into your monitor by inserting the air plug into the air jack securely until it clicks.**

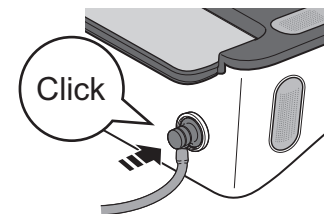

3. Taking a Blood Pressure Measurement and Recording an EKG

2. Place your hand through the cuff loop. Pull the cuff until it reaches your upper left arm.

Note

- The bottom edge of the arm cuff should be 0.5 inch (1 to 2 cm) above the inside elbow. The air tube is on the inside of your arm and aligned with your middle finger.

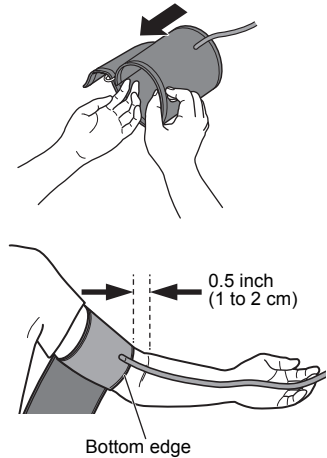

3. Make sure that the air tube is positioned on the inside of your arm and wrap the cuff securely so it can not move around your arm.

Note

- When you take a measurement on your right arm, the air tube should run along the side of your elbow, along the bottom of your arm. Be careful not to rest your arm on the air tube.

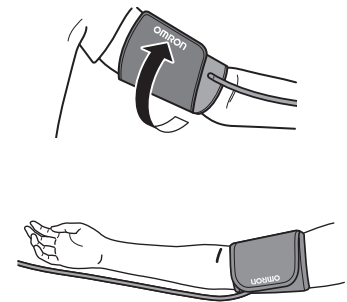

3. Taking a Blood Pressure Measurement and Recording an EKG

3.2 Sitting Correctly

To take a blood pressure measurement and record an EKG, you need to be relaxed and comfortably seated in a quiet room with a comfortable temperature.

- Sit in a comfortable chair with your back and arms supported.
- Keep your feet flat and your legs uncrossed.
- Both arms should be resting comfortably on a table.
- Place your monitor close enough to touch with your bent elbows.
- The arm cuff should be placed on your arm at the same level as your heart for a blood pressure measurement.

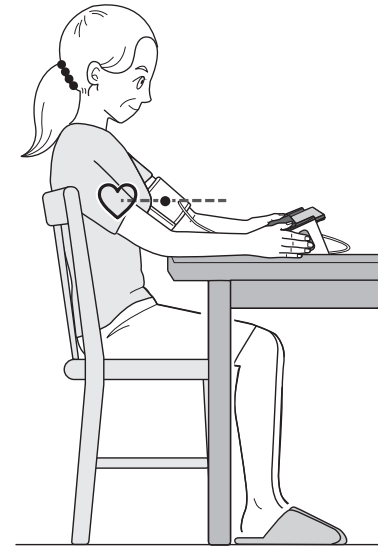

3. Taking a Blood Pressure Measurement and Recording an EKG

3.3 Taking a Blood Pressure Measurement and Recording an EKG

Free medical interpretation of your first EKG recording

A U.S. board-certified cardiologist will automatically review your first EKG recording for free and will provide a medical interpretation within 24 hours. Due to FDA regulations, the heart rhythm for your first recording will not be visible on your smartphone screen and you will not be able to record any additional EKGs while the cardiologist is preparing your report. After you receive your report notification by email, you will be able to view and record your further EKGs.

Note

- If you have created an account with the referral code, you can view from your first EKG. Refer to sub-section 2.2 for details.

Note

- To stop a blood pressure measurement and an EKG recording, release both your hands from the electrodes and press the BP [START/STOP] button on the monitor to deflate the arm cuff.

Caution

- DO NOT use this monitor with other medical electrical (ME) equipment simultaneously. This may result in incorrect operation of the monitor and/or cause inaccurate blood pressure readings and/or EKG recordings.
- Remain still and DO NOT talk while taking a blood pressure measurement.
- Remain still while recording an EKG.
- When your fingertips are dry, your EKG recording may not be successful. If dry, moisten your fingers with a wet towel, a water-based lotion, or something similar.
- DO NOT record an EKG with dirty hands.
- Make sure to place your smartphone on the smartphone stand of the monitor when recording an EKG. If it is not placed appropriately on the smartphone stand, it may lead to communication issues between the smartphone and the monitor, and your EKG may not be recorded successfully.

3. Taking a Blood Pressure Measurement and Recording an EKG

1. Open the “OMRON connect US/CAN” app on your smartphone.

2. Tap “Record your (first) EKG” on your smartphone, and follow the instructions.

Note

- The instructions for recording your first EKG will not appear with the next recording, and it will not appear if you have created an account with referral code.

3. Place your smartphone on the smartphone stand of your monitor.



Note

- Make sure to sit correctly. Refer to sub-section 3.2.

4. Press the BP [START/STOP] button to take a blood pressure measurement.

All symbols appear on the BP reading display of the monitor before starting.

The arm cuff will start inflating in few seconds.

3. Taking a Blood Pressure Measurement and Recording an EKG

5. Touch 4 electrodes as shown in the image.

Put your thumbs on the top electrodes, and 2 or more fingers on each of the side electrodes to record your EKG.

Once fingers are placed on the electrodes, an EKG recording will automatically start.

Note

- To reduce muscle noise, rest your arms on a flat surface for better support while you are recording an EKG.
- To link both results (blood pressure readings and EKG recordings) mutually on the app, touch 4 electrodes as soon as pressing the BP [START/STOP] button.

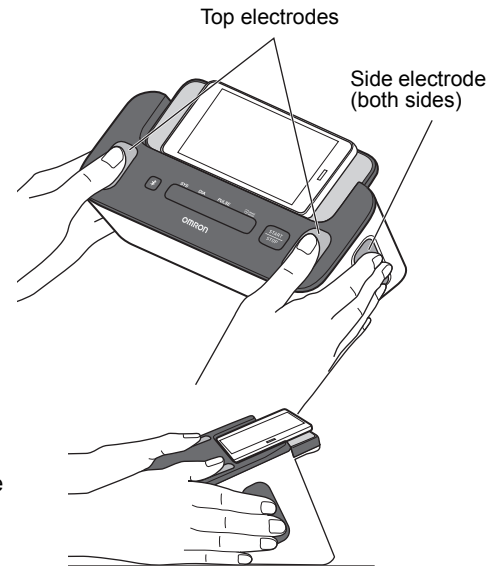

6. Remain still and do not talk until the entire measurement and recording process is complete.

3. Taking a Blood Pressure Measurement and Recording an EKG

Blood pressure measurement

- 1) The “” symbol flashes at every heartbeat.
- 2) After your monitor has detected your blood pressure and pulse rate, the cuff automatically deflates. Your blood pressure and pulse rate are displayed on the monitor.
- 3) As soon as a blood pressure measurement is complete, the blood pressure reading will be transferred to your smartphone.

Note

- On the paired smartphone, Bluetooth must be enabled.

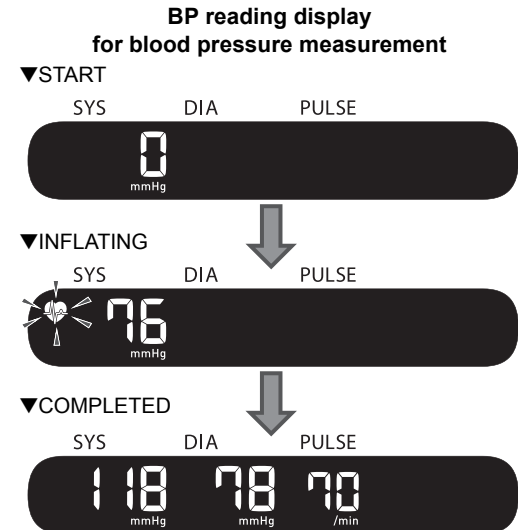

3. Taking a Blood Pressure Measurement and Recording an EKG

EKG recording

When recording an EKG for the first time, EKG wave and analysis are not visible but a 30-second countdown is shown. A message of waiting for a report from the cardiologist within 24 hours appears on the “OMRON connect US/CAN” app. After receiving a report, following EKG wave and analysis will be visible.

If you have created an account with referral code, following EKG wave and analysis will be visible from the first EKG recording.

- 1) The app starts a 30-second countdown and shows the EKG wave on your smartphone.
- 2) After completion of an EKG recording, an EKG instant analysis (Possible Atrial Fibrillation, Bradycardia, Tachycardia, Normal, Unreadable, Unclassified or other messages) appears on the left side on your smartphone screen. Refer to sub-section 1.5 for details.

Note

- The app will detect if someone accidentally uses your smartphone to record an EKG, and ask if you or someone else took the EKG after completion. Do not release both hands until your monitor detects the blood pressure reading.

- 3) Blood pressure reading also appears on the right side on your smartphone screen.

Note

- The recording must be at least 30 seconds to complete, and to be analyzed by the detectors.
- When your smartphone screen is inverted, check the auto rotation setting on your smartphone. Or visit the “Support” section on the app.

Display of your smartphone for EKG recording

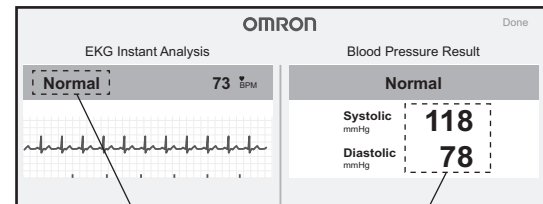
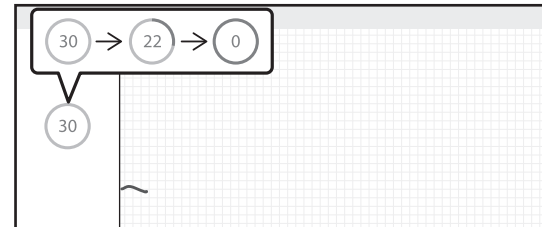

EKG Instant Analysis

Blood pressure reading

3. Taking a Blood Pressure Measurement and Recording an EKG

7. Release both of your hands from the electrodes and remove the arm cuff.

Note

- After taking a blood pressure measurement and recording an EKG, you can promptly add tags such as symptoms, activities, diet, etc. on the app. You may also add personalized notes, and send your EKG recording by email.

8. Press the BP [START/STOP] button to turn your monitor off.

Note

- Your monitor will automatically turn off after 2 minutes.
- Wait 2-3 minutes between blood pressure measurements. The wait time allows the arteries to decompress and return to their pre-measurement state. You may need to increase the wait time depending on your individual physiological characteristics.
- Your monitor stores up to 90 blood pressure readings in the internal memory, but the previous readings cannot be viewed on the monitor.
- If your systolic blood pressure is more than 210 mmHg, take a blood pressure measurement manually. Refer to section 7.

4. Taking Only a Blood Pressure Measurement

Note

- You can take a blood pressure measurement without pairing to a smartphone. To pair your monitor with your smartphone, refer to sub-section 2.2.
- When taking a blood pressure measurement and recording an EKG simultaneously, refer to section 3.
- When recording only an EKG, refer to section 5.

Caution

- DO NOT use this monitor with other medical electrical (ME) equipment simultaneously. This may result in incorrect operation of the monitor and/or cause inaccurate blood pressure readings and/or EKG recordings.
- Remain still and DO NOT talk while taking a blood pressure measurement.

- 1. Apply the arm cuff. Refer to sub-section 3.1.**
- 2. Sit correctly. Refer to sub-section 3.2.**
- 3. Press the BP [START/STOP] button to take a blood pressure measurement.**

All symbols appear on the BP reading display of the monitor before starting. The arm cuff will start inflating in few seconds.

Note

- To stop a blood pressure measurement, press the BP [START/STOP] button once to deflate the arm cuff.

4. Taking Only a Blood Pressure Measurement

4. Remain still and do not talk until the entire measurement process is complete.

- 1) The “” symbol flashes at every heartbeat.
- 2) After your monitor has detected your blood pressure and pulse rate, the cuff automatically deflates. Your blood pressure and pulse rate are displayed on the monitor.

Note

- If your monitor has not been paired with your smartphone, skip following steps 3) and 4).

- 3) As soon as your measurement is complete, open the “OMRON connect US/CAN” app on your smartphone to transfer your readings.

Note

- On the paired smartphone, Bluetooth must be enabled.
- If you need to transfer the readings manually, refer to section 6.

- 4) You can view your blood pressure readings on the app.

5. Remove the arm cuff.

6. Press the BP [START/STOP] button to turn your monitor off.

Note

- Your monitor will automatically turn off after 2 minutes.
- Wait 2-3 minutes between blood pressure measurements. The wait time allows the arteries to decompress and return to their premeasurement state. You may need to increase the wait time depending on your individual physiological characteristics.
- Your monitor stores up to 90 blood pressure readings in the internal memory, but the previous readings cannot be viewed on the monitor.
- If your systolic blood pressure is more than 210 mmHg, take a blood pressure measurement manually. Refer to section 7.

5. Recording Only an EKG

Note

- When taking a blood pressure measurement and recording an EKG simultaneously, refer to section 3.
- When taking only a blood pressure measurement, refer to section 4.

Caution

- Remain still while recording an EKG.
- When your fingertips are dry, your EKG recording may not be successful. If dry, moisten your fingers with a wet towel, a water-based lotion, or something similar.
- DO NOT record an EKG with dirty hands.
- Make sure to place your smartphone on the smartphone stand of the monitor when recording an EKG. If it is not placed appropriately on the smartphone stand, it may lead to communication issues between the smartphone and the monitor, and your EKG may not be recorded successfully.

- 1. Sit correctly. Refer to sub-section 3.2.**
- 2. Open the “OMRON connect US/CAN” app on your smartphone.**
- 3. Tap “Record your (first) EKG” on your smartphone, and follow the instructions.**

Note

- The instructions for recording your first EKG will not appear with the next recording, and it will not appear if you have created an account with referral code.

5. Recording Only an EKG

4. Place your smartphone on the smartphone stand of your monitor.

5. Touch 4 electrodes as shown in the image.

Put your thumbs on the top electrodes, and 2 or more fingers on each of the side electrodes to record your EKG.

Once fingers are placed on the electrodes, an EKG recording will automatically start.

Note

- To reduce muscle noise, rest your arms on a flat surface for better support while you are recording an EKG.

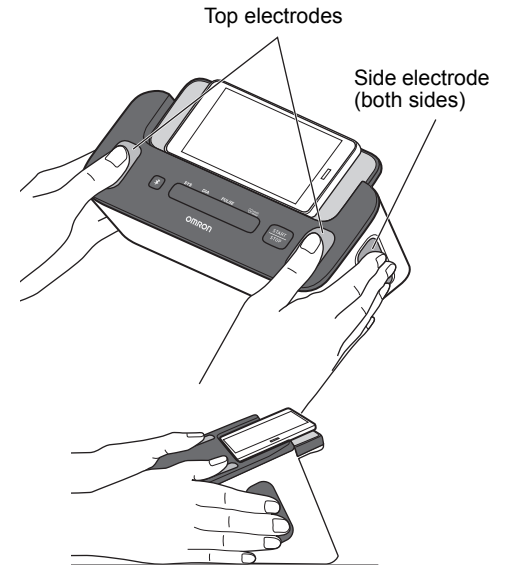

5. Recording Only an EKG

6. Remain still until the entire recording process is complete.

When recording an EKG for the first time, EKG wave and analysis are not visible but a 30-second countdown is shown. A message of waiting for a report from the cardiologist within 24 hours appears on the “OMRON connect US/CAN” app. After receiving a report, EKG wave and analysis will be visible.

If you have created an account with referral code, EKG wave and analysis will be visible from the first EKG recording.

- 1) The app starts a 30-second countdown and shows the EKG wave on your smartphone.
- 2) After completion of an EKG recording, an instant EKG analysis (Possible Atrial Fibrillation, Bradycardia, Tachycardia, Normal, Unreadable, Unclassified or other messages) will appear on your smartphone. Refer to sub-section 1.5 for details.

Note

- The app will detect if someone accidentally uses your smartphone to record an EKG, and ask if you or someone else took the EKG after completion.
- The recording must be at least 30 seconds to complete, and to be analyzed by the detectors.
- When your smartphone screen is inverted, check the auto rotation setting on your smartphone. Or visit the “Support” section on the app.

7. Release both of your hands from the electrodes.

Note

- If you accidentally pressed the BP [START/STOP] button, press the button again to stop the blood pressure measurement process.
- After recording an EKG, you can promptly add tags such as symptoms, activities, diet, etc. on the app. You may also add personalized notes, and send your EKG recording by email.

6. Transfer Your Blood Pressure Readings Manually

As soon as a blood pressure measurement is complete, open the “OMRON connect US/CAN” app on your smartphone to transfer your readings. If you need to transfer the readings later, try transferring them manually.

1. Make sure your monitor is within 16 ft. (5 m) of your smartphone.

2. Open the “OMRON connect US/CAN” app on your smartphone.

Note



- Make sure that your monitor is turned off. If it is on, press the BP [START/STOP] button to clear the LCD screen.

3. Press the  button on the monitor to transfer your readings.

If your blood pressure readings are successfully transferred to the app, “OK” will flash on the BP reading display of the monitor.

4. Press the BP [START/STOP] button to turn your monitor off.

Note

- Your monitor will automatically turn off after 10 seconds.
- This monitor will store up to 90 blood pressure readings. Stored blood pressure readings cannot be viewed on the BP reading display of the monitor. You can view your blood pressure readings on the app after transferring. When the “” symbol appears on the BP reading display, the stored memory on the monitor is almost full. Transfer the readings immediately before your readings are deleted.
- When the “off” symbol appears on the BP reading display of the monitor, enable Bluetooth of your monitor. Refer to sub-section 8.1.
- Once you send your blood pressure readings to the app, the readings cannot be sent again to the app or smartphone.

7. Taking a Blood Pressure Measurement Manually

If your systolic blood pressure is more than 210 mmHg, take a blood pressure measurement manually.

Prepare for taking a blood pressure measurement by referring to sub-sections 3.1 and 3.2.

And press the BP [START/STOP] button.

After the arm cuff starts to inflate, press and hold the BP [START/STOP] button until the monitor inflates 30 to 40 mmHg higher than your expected systolic blood pressure.

Note

- Do not inflate above 299 mmHg.

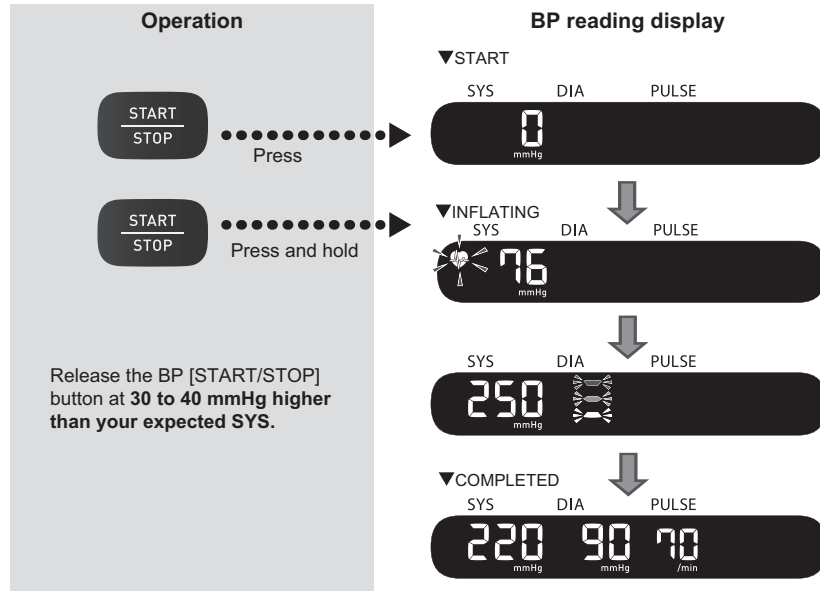

⚠ Caution

- Inflating to a higher pressure than necessary may result in bruising of the arm where the cuff is applied.

8. Other Settings on the Monitor

8.1 Disabling/Enabling Bluetooth

Warning

- This product emits radio frequencies (RF) in the 2.4 GHz band. DO NOT use this product in locations where RF is restricted, such as on an aircraft or in hospitals. Turn off the Bluetooth feature in this monitor and remove batteries when in RF restricted areas. For further information on potential restrictions refer to documentation on the Bluetooth usage by the FCC.

Bluetooth is enabled as default.



1. **When your monitor is off, press and hold the  button on the monitor for more than 10 seconds.**

“oFF” appears on the BP reading display.



2. **Press the BP [START/STOP] button to turn your monitor off.**

Note

- When Bluetooth is disabled, the “off” symbol appears.
- To enable Bluetooth, press and hold the  button for more than 2 seconds. “on” appears on the BP reading display.
- Your monitor will automatically turn off within 2 minutes after completion.



8. Other Settings on the Monitor

8.2 Restoring Your Monitor to the Default Settings

To delete all the information stored in your monitor, follow the instructions below. Make sure that your monitor is turned off.

-
1. While holding the  button down, press and hold the BP [START/STOP] button for more than 10 seconds.



-
2. Release the button and BP [START/STOP] button when “CLr” appears on the BP reading display.

Your monitor reverts back to the default settings.



-
3. Press the BP [START/STOP] button to turn your monitor off.



Note

- Reverting to the default settings of your monitor does not delete the information in the app.
- Your monitor will automatically turn off after 2 minutes.
- You will need to re-pair your monitor when using the monitor again. Without re-pairing, your readings will not be transferred to your app.







9. Error Messages and Troubleshooting

If any of the below problems occur during a blood pressure measurement and an EKG recording, check to make sure that the monitor is 12 inches (30 cm) from other electrical devices, except for the smartphone that is being used with the monitor. For example, electrical outlets, PCs, PC monitors or other wireless devices such as Wi-Fi routers which emit radio frequencies. If the problem persists, refer to the table below.







Monitor and blood pressure measurements

BP reading display / Problem	Possible Cause	Solution
 <p>E1 appears or the arm cuff does not inflate.</p>	The BP [START/STOP] button was pressed while the arm cuff is not applied.	Press the BP [START/STOP] button again to turn the monitor off. After inserting the air plug securely and applying the arm cuff correctly, press the BP [START/STOP] button.
	Air plug is not completely plugged into the monitor.	Insert the air plug securely. Refer to sub-section 3.1.
	The arm cuff is not applied correctly.	Apply the arm cuff correctly, then take another measurement. Refer to sub-section 3.1.
	Air is leaking from the arm cuff.	Replace the arm cuff with a new one. Refer to section 11.
 <p>E2 appears or a measurement cannot be complete after the arm cuff inflates.</p>	You move or talk during a measurement and the arm cuff does not inflate sufficiently.	Remain still and do not talk during a blood pressure measurement. If “E2” appears repeatedly, inflate the arm cuff manually until the systolic pressure is 30 to 40 mmHg above your previous readings. Refer to section 7.
	The systolic blood pressure is above 210 mmHg and a measurement cannot be taken.	Inflate the arm cuff manually until the systolic pressure is 30 to 40 mmHg above your previous readings. Refer to section 7.

9. Error Messages and Troubleshooting

BP reading display / Problem	Possible Cause	Solution
 appears	The arm cuff was inflated exceeding the maximum allowable pressure.	Do not touch the arm cuff and/or bend the air tube while taking a measurement. If inflating the arm cuff manually, refer to section 7.
 appears	You move or talk during a measurement. Vibrations disrupt a measurement.	Remain still and do not talk during a measurement.
 appears	The pulse rate is not detected correctly.	Apply the arm cuff correctly, then take another measurement. Refer to sub-section 3.1. Remain still and sit correctly during a measurement.
 appears		
 does not flash during a measurement.		
 appears	The monitor has malfunctioned.	Press the BP [START/STOP] button again. If “Er” still appears, contact customer service. Refer to section 14.

9. Error Messages and Troubleshooting

BP reading display / Problem	Possible Cause	Solution
 appears	The monitor cannot connect to a smartphone or transmit blood pressure readings correctly.	Follow the instructions shown in the “OMRON connect US/CAN” app. If the “Err” symbol still appears after checking the app, contact customer service. Refer to section 14.
 flashes	The monitor is waiting to pair with the smartphone.	Refer to sub-section 2.2 for pairing your monitor with your smartphone.
 flashes	The monitor is ready to transfer blood pressure readings to the smartphone.	Open the “OMRON connect US/CAN” app to transfer your blood pressure readings.
 flashes	Internal stored blood pressure memory is almost full.	Pair or transfer your blood pressure readings to the “OMRON connect US/CAN” app so you can keep them in memory in the app, and this error symbol disappears.
 appears	Internal stored blood pressure memory is completely full.	
 appears	Batteries are low.	Replacing all 4 batteries with new ones is recommended. Refer to sub-section 2.1.

9. Error Messages and Troubleshooting

BP reading display / Problem	Possible Cause	Solution
 appears or the monitor is turned off unexpectedly during a measurement.	Batteries are depleted.	Immediately replace all 4 batteries with new ones. Refer to sub-section 2.1.
Nothing appears on the BP reading display of the monitor.	Batteries are depleted.	Check the battery installation for proper placement. Refer to sub-section 2.1.
Blood pressure readings appear too high or too low.	Blood pressure varies constantly. Many factors including stress, time of day, and/or how you apply the arm cuff, may affect your blood pressure. Review sub-sections 2.3, 3.1 and 3.2.	
Any other problems occur.	Press the BP [START/STOP] button to turn the monitor off, then press it again to take a blood pressure measurement. If the problem continues, remove all batteries and wait for 30 seconds. Then, reinstall batteries. If the problem still persists, contact customer service. Refer to section 14.	

9. Error Messages and Troubleshooting

EKG recordings

Problem	Solution
I have a lot of artifact, noise, interference, or see “No EKG” in my EKG recording.	Ensure that the “OMRON connect US/CAN” app has access to the microphone of the smartphone. Open the settings of your smartphone, and enable the microphone of the app.
	Try the following tips for acquiring the best quality EKG recording: <ul style="list-style-type: none">• Clean the electrodes of the monitor with an alcohol-based sanitizer.• If hands are very dry, use a water-based lotion before recording.• Relax both arms and hands to reduce muscle noise. Both arms should be resting comfortably on a table.• Ensure that your smartphone is not charging/ syncing and you are not using headphones or any other connected devices with your smartphone during the EKG recording.• Make sure that both the smartphone and the user remain still during EKG recordings. Movement during recordings will cause noise in the tracing.
The HUD symbol is covered up when I rotate my smartphone	The heads up display (HUD) symbol can sometimes be partially obstructed when you rotate your smartphone while it’s busy. This isn’t a concern; the HUD symbol is just letting you know that the app is working. This doesn’t impact your EKG recording or any of your information.
I see large spikes at the start of my EKG recording	Large amounts of noise/artifact can be seen for the first few milliseconds of an EKG recording when the enhanced filter is looking for your heartbeat. This is very rare and only lasts until your first heartbeat is seen in the app; this doesn’t affect the rest of your EKG recording.
Any other communication issue occurs.	Follow the instructions shown in the smartphone, or visit the “Support” section in the “OMRON connect US/CAN” app for further help. If the problem still persists, contact customer service. Refer to section 14.

10. Maintenance

10.1 Maintenance

To protect your monitor from damage, follow the directions below:

- Changes or modifications not approved by the manufacturer will void the user warranty.

Caution

- DO NOT disassemble or attempt to repair this monitor or other components. This may cause an inaccurate blood pressure readings and/or EKG recordings.

10.2 Storage

Keep your monitor and other components in the storage case when not in use.

- Store your monitor and other components in a clean, safe location.

1. Remove the arm cuff from the monitor.

2. Gently fold the air tube into the arm cuff.

Note

- Do not bend or crease the air tube excessively.

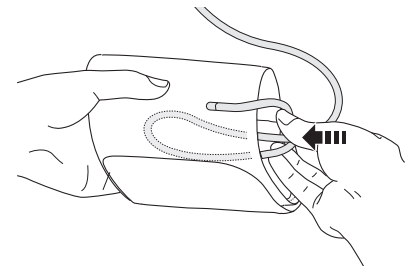

Caution

- To unplug the air plug, pull on the plastic air plug at the base of the tube, not the tube itself.

10. Maintenance

3. Place your monitor with both hands and other components into the storage case.

Do not store your monitor and other components:

- If the monitor and other components are wet.
- In locations exposed to extreme temperatures, humidity, direct sunlight, dust or corrosive vapors such as bleach.
- In locations exposed to vibrations or shocks.

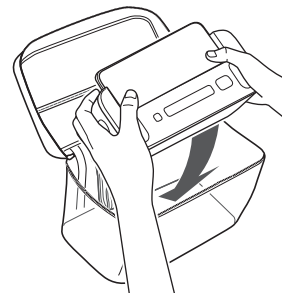

10.3 Cleaning

- Do not use any abrasive or volatile cleaners.
- Use a soft dry cloth or a soft cloth moistened with mild (neutral) detergent to clean your monitor and the arm cuff and then wipe them with a dry cloth.
- When electrodes are dirty, use a soft cloth or cotton swab moistened with alcohol-based sanitizer to clean the electrodes.
- Do not use alcohol to clean any other parts, and use it only to clean electrodes.
- Do not wash or immerse your monitor and arm cuff or other components in water.
- Do not use gasoline, thinners or similar solvents to clean your monitor and arm cuff or other components.

10.4 Disposal

Dispose of the monitor, other components and optional accessories according to applicable local regulations. Unlawful disposal may cause environmental pollution.

11. Optional Accessories

Arm cuff

Arm circumference
7" - 9" (17 - 22 cm)

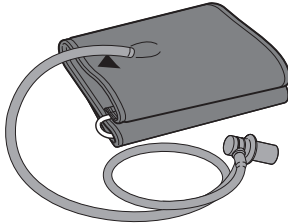

Small D-Ring Cuff

Model: HEM-CS24-B [REF](#) HEM-CS24-BZ

Arm circumference
9" - 17" (22 - 42 cm)

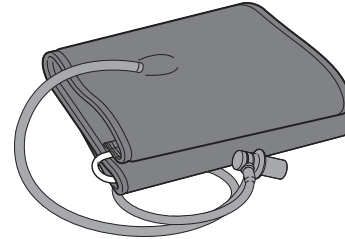

Wide-Range D-Ring Cuff

Model: HEM-RML31-B [REF](#) HEM-RML31-BZ

- Same as the arm cuff provided with the product.

Note

- Do not throw the air plug away. The air plug can be applicable to the optional cuff.

12. Specifications

Model	BP7900 REF HEM-7530T-Z
BP reading display	LCD digital display
Transmission method	Bluetooth ® Low Energy
Wireless communication	Frequency range: 2.4 GHz (2400 - 2483.5 MHz) Modulation: GFSK Effective radiated power: <20 dBm Continuous operation
Operation mode	IP 21
IP classification	DC6 V 4 W
Rating	4 "AA" alkaline batteries 1.5 V
Power source	Approximately 300 measurements (using new alkaline batteries)
Battery life	Monitor: 5 years Cuff: 5 years
Durable period (Service life)	+50 °F to +104 °F (+10 °C to +40 °C) / 15 to 90 % RH (non-condensing) / 800 to 1060 hPa
Operating conditions	-4 °F to +140 °F (-20 °C to +60 °C) / 10 to 90 % RH (non-condensing)
Storage / Transport conditions	Monitor: Approximately 19.4 oz. (550 g) not including batteries Arm cuff: Approximately 6 oz. (170 g)
Weight	Monitor: Approximately 9.1" (w) × 3.9" (h) × 4.8" (l) (232 mm × 98 mm × 123 mm) Arm cuff: Approximately 5.7" × 23.4" (air tube: 29.5") (145 mm × 594 mm (air tube: 750 mm)) 7" to 17" (170 to 420 mm) (included arm cuff: 9" to 17" (220 to 420 mm))
Dimensions	
Cuff circumference applicable to the monitor	
Internal Memory	Stores up to 90 blood pressure readings
Applied part	Type BF (arm cuff), Type CF (electrodes)
Protection against electric shock	Internally powered ME equipment
Maximum temperature of the applied part	Lower than +118.4 °F (+48 °C)
Contents	Monitor, Wide-Range D-Ring Cuff, storage case, 4 "AA" alkaline batteries, instruction manual, quick start guide

12. Specifications

Blood pressure measurement

Cuff pressure range

0 to 299 mmHg

Blood pressure measurement range

SYS: 60 to 260 mmHg

DIA: 40 to 215 mmHg

Pulse measurement range

40 to 180 beats / min.

Accuracy

Pressure: ± 3 mmHg

Pulse: ± 5 % of display reading

Inflation

Automatic by electric pump

Deflation

Automatic pressure release valve

Measurement method

Oscillometric method

EKG recording

Performance characteristics

EKG channel: Single channel

Input dynamic range: 10 mV Peak-to-Peak

Frequency response: 0.67 Hz to 40 Hz

CMRR: > 60 dB

Input Impedance: > 10 MOhm

Output

Modulation: Frequency modulated ultrasonic audio tone

Center frequency: 19 kHz

Modulation index: 200 Hz/mV

12. Specifications



Note

- These specifications are subject to change without notice.
- In the clinical validation study, K5 was used on 85 subjects for determination of diastolic blood pressure.
- This monitor is comply with the requirements of ISO 81060-2:2013.
- This monitor has not been validated for use on pregnant patients.
- IP classification is degrees of protection provided by enclosures in accordance with IEC 60529. This monitor is protected against solid foreign objects of 0.5 inch (12.5 mm) diameter and greater such as a finger, and against vertically falling water drops which may cause issues during a normal operation.
- The heart rate displayed during EKG acquisition is an average over the last 5 seconds.
- The heart rate displayed in review and on reports is the average heart rate over the entire EKG recording.
- The heart rate during recording an EKG has a range from 30 bpm to 300 bpm, and a resolution of 1 bpm.

About a wireless communication interference

This Product operates in an unlicensed ISM band at 2.4 GHz. In the event this Product is used near other wireless devices such as microwave and wireless LAN, which operate on the same frequency band as this Product, there is a possibility that interference may occur. If interference occurs, stop the operation of the other devices or relocate this Product away from other wireless devices before attempting to use it.

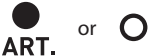
Pictogram on the Product

 <p>ART.</p>	Types of marks used to indicate the correct positioning of the artery for the upper arm
	Identifies the type of cuff that is compatible with the blood pressure monitor

13. FCC Statement

FCC CAUTION

Changes or modifications not expressly approved by the party responsible for compliance could void the user's authority to operate the equipment.

This device complies with part 15 of the FCC Rules. Operation is subject to the following two conditions:

(1) This device may not cause harmful interference, and (2) this device must accept any interference received, including interference that may cause undesired operation.

Note

This equipment has been tested and found to comply with the limits for a Class B digital device, pursuant to part 15 of the FCC Rules. These limits are designed to provide reasonable protection against harmful interference in a residential installation. This equipment generates, uses and can radiate radio frequency energy and, if not installed and used in accordance with the instructions, may cause harmful interference to radio communications. However, there is no guarantee that interference will not occur in a particular installation. If this equipment does cause harmful interference to radio or television reception, which can be determined by turning the equipment off and on, the user is encouraged to try to correct the interference by one or more of the following measures:

- Reorient or relocate the receiving antenna.
- Increase the separation between the equipment and receiver.
- Connect the equipment into an outlet on a circuit different from that to which the receiver is connected.
- Consult the dealer or an experienced radio/TV technician for help.

This transmitter must not be co-located or operated in conjunction with any other antenna or transmitter.

This equipment complies with FCC radiation exposure limits set forth for an uncontrolled environment and meets the FCC radio frequency (RF) Exposure Guidelines. This equipment has very low levels of RF energy that are deemed to comply without testing of specific absorption ratio (SAR).

14. Limited Warranty

Your BP7900 Blood Pressure Monitor + EKG, excluding the arm cuff and batteries are warranted to be free from defects in materials and workmanship appearing within 5 years from the date of purchase, when used in accordance with the instructions provided with the monitor. The arm cuff is warranted to be free from defects in materials and workmanship appearing within 1 year from the date of purchase when the monitor is used in accordance with the instructions provided with the monitor. The above warranty extends only to the original retail purchaser, and only to products purchased from an Omron authorized seller who is subject to and follows Omron's quality control standards, unless otherwise prohibited by law.

We will, at our option, replace without charge any monitor or arm cuff covered by the above warranty. Replacement is our only responsibility and your only remedy under the above warranty.

To obtain warranty service contact Customer Service by calling **1-800-634-4350** for the address of the inspection center and the return shipping and handling fee.

Enclose the original printed receipt. Include a letter, with your name, address, phone number, and description of the specific problem. Pack the product carefully to prevent damage in transit. Because of possible loss in transit, we recommend insuring the product with return receipt requested.

THE FOREGOING IS THE SOLE WARRANTY PROVIDED BY OMRON IN CONNECTION WITH THIS PRODUCT, AND OMRON HEREBY DISCLAIMS ANY OTHER WARRANTIES, EXPRESS OR IMPLIED, INCLUDING IMPLIED WARRANTIES OF MERCHANTABILITY AND FITNESS FOR A PARTICULAR PURPOSE. IMPLIED WARRANTIES AND OTHER TERMS THAT MAY BE IMPOSED BY LAW, IF ANY, ARE LIMITED IN DURATION TO THE PERIOD OF THE ABOVE EXPRESS WARRANTY.

OMRON SHALL NOT BE LIABLE FOR LOSS OF USE OR ANY OTHER SPECIAL, INCIDENTAL, CONSEQUENTIAL OR INDIRECT COSTS, EXPENSES OR DAMAGES.

This warranty provides you with specific legal rights, and you may have other rights that vary by jurisdiction. Because of special local requirements, some of the above limitations and exclusions may not apply to you.

FOR CUSTOMER SERVICE

Visit our web site at:

Call toll free:

OmronHealthcare.com

1-800-634-4350

15. Guidance and Manufacturer's Declaration

OMRON Battery-operated Blood Pressure Monitor + EKG

Information for Accompanying Documents in the Scope of IEC60601-1-2:2014

Important information regarding Electromagnetic Compatibility (EMC)

BP7900 conforms to IEC60601-1-2:2014 Electromagnetic Compatibility (EMC) standard.

Further documentation in accordance with this EMC standard is available at OmronHealthcare.com/emc. Refer to the EMC information for BP7900 on the website.

Notes

The **Bluetooth**[®] word mark and logos are registered trademarks owned by the Bluetooth SIG, Inc. and any use of such marks by OMRON HEALTHCARE Co., Ltd. is under license.

Other trademarks and trade names are those of their respective owners.

Apple and the Apple logo, are trademarks of Apple Inc., registered in the U.S. and other countries and regions. App Store and App Store logo are service marks of Apple Inc.

Google Play and the Google Play logo are trademarks of Google LLC.

The AliveCor[®] word mark and logo are owned by AliveCor, Inc. and are used with permission.

United States patents and patents pending: 8,509,882; 9,649,042; 8,301,232; 2017/0215755; 9,247,911; 9,681,814; 2017/0215756.



OMRON HEALTHCARE Co., Ltd.

53, Kunotsubo, Terado-cho, Muko, Kyoto, 617-0002 JAPAN

Distributed by:

OMRON HEALTHCARE, INC.

1925 West Field Court, Lake Forest, IL 60045 U.S.A.

OmronHealthcare.com

© 2020 OMRON HEALTHCARE, INC.

Made in Japan